

EVOLVE WALL VANITY 1200 4 X DRAWER - POLYMARBLE DEZIGNA
WHITE GLOSS

ELEMENTI

28440.11

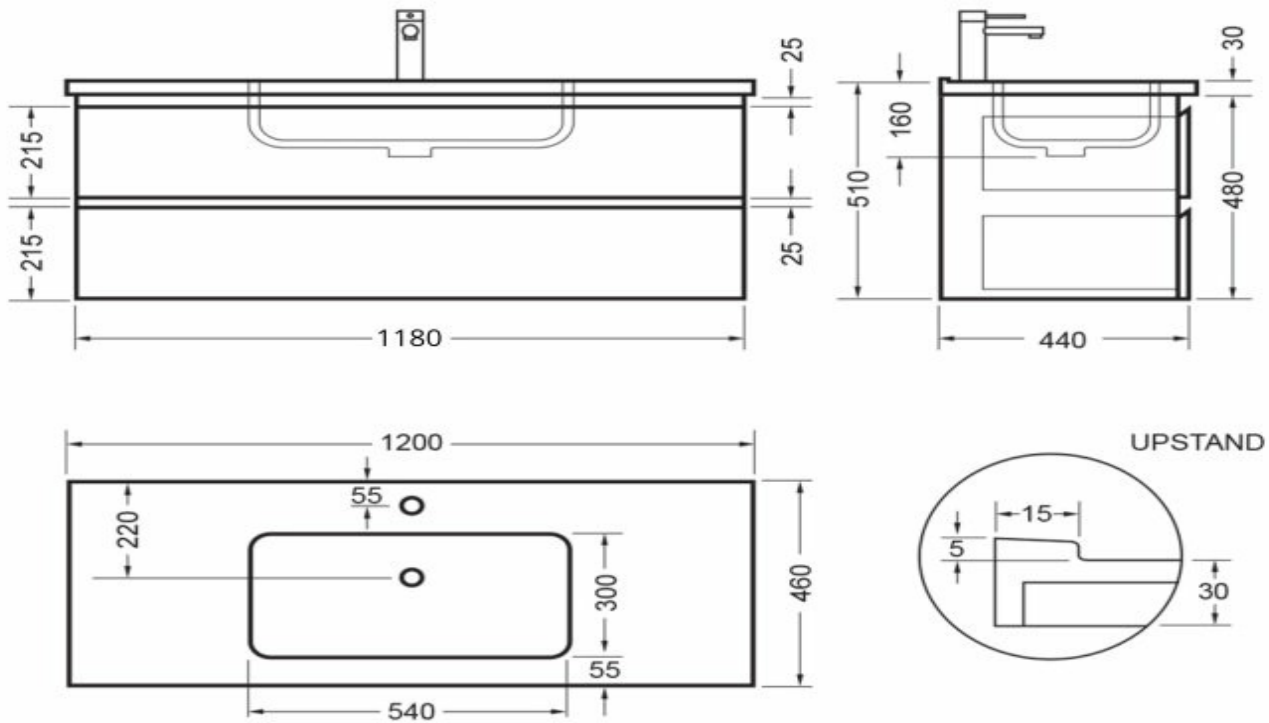

Residential/Light
Commercial

Suitable for Residential/Light Commercial Use (Kitchens,
Bathrooms and Laundries in Motels, Hotels and
Retirement Villages)

5

Guarantee

5 Year Guarantee (Basin &
Cabinet)

10

Guarantee

10 Year Guarantee (Tavolo Top)



Hafele Lifetime
Warranty

All Hafele Hardware comes with a Lifetime Warranty.



Moisture Resistant

Made from Moisture Resistant Board





Soft Close Drawer
System

Incorporates Soft Close Drawer System.



Made in New
Zealand

The Evolve Vanity is made up of a combination of imported contemporary products and New Zealand made furniture combining high quality components and materials with superior craftsmanship to produce crisp, cutting edge designs that are not only beautiful but built to last.