

# SPECIFICATION SHEET

## Porscha Luxe 900 2-Drawer Wall Hung Vanity



### Features

- 2-Drawer Wall Hung Vanity - Colour options below
- Full Extension Soft Close Drawers with Extrusions - Extrusion upgrade options available
- Designer Drawer Front - Four Drawer Front options
- Dimensions: H670 x W900 x D465
- Slab Top Options:  
20mm StoneCast Top or Quartz Slab Top

*Note: Vessel basins are purchased separately.  
Visit [www.newtech.co.nz](http://www.newtech.co.nz) for the full range of vessel basin options.*

### Cabinet Options

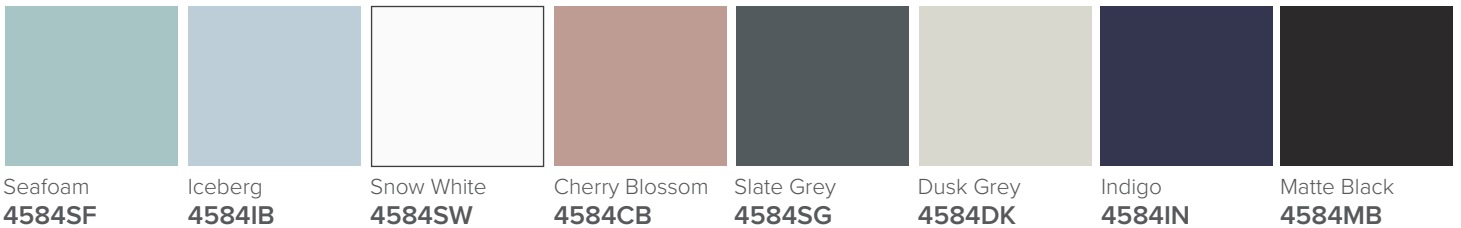

### StoneCast Slab Top Options



### Quartz Slab Top Options

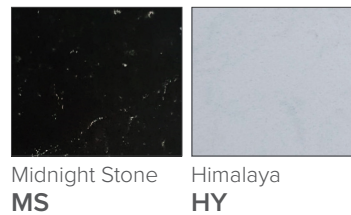

*Note: To order a Slab Top, add the Slab Top code to the cabinet code*

### Technical Details

*Note: All measurements shown are in millimetres. Sizes are nominal.*

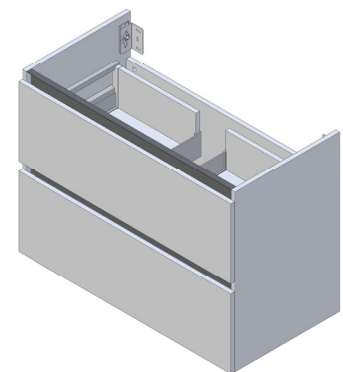
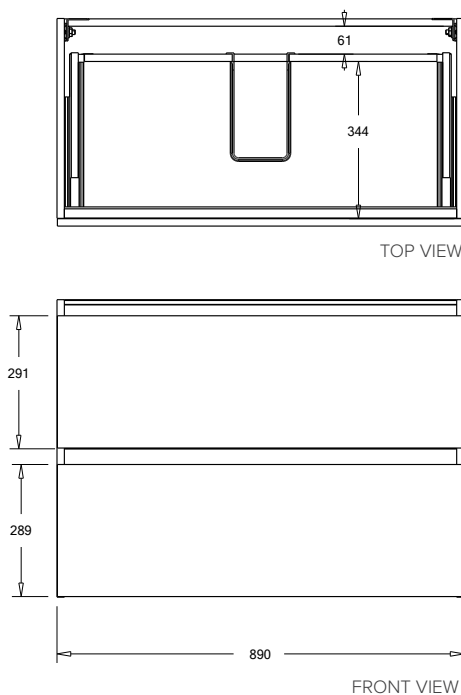

# SPECIFICATION SHEET

## Porscha Designer Drawer Fronts

**BARNSLEY**  
18mm Inset Frame  
Code: BL

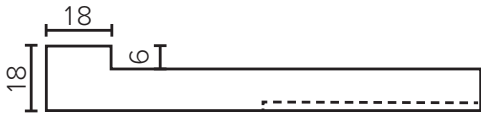
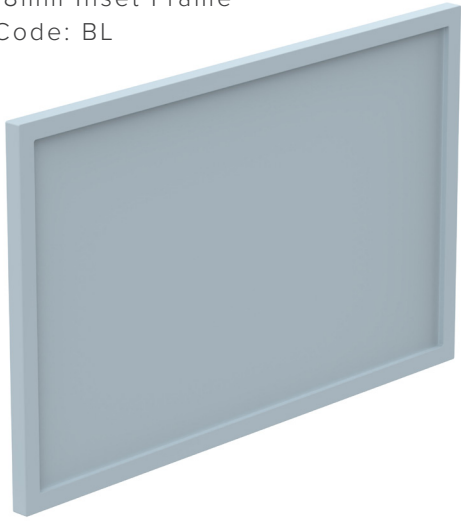

**PRESTON**  
60mm Inset Frame  
Code: PT

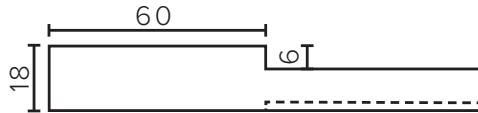
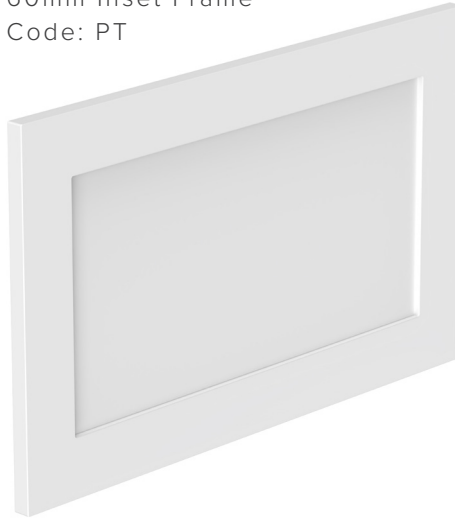

**TURNBERRY**  
Ripple Design Panel  
Code: TB

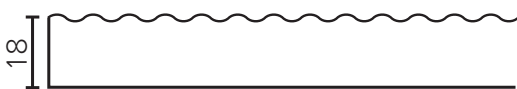
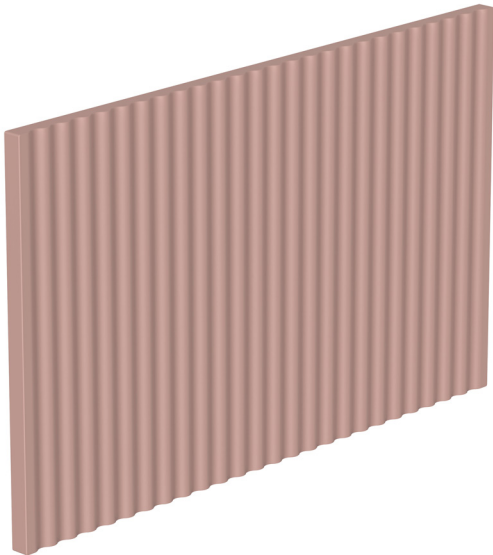

**NEWPORT**  
V-Groove Panels  
Code: NP

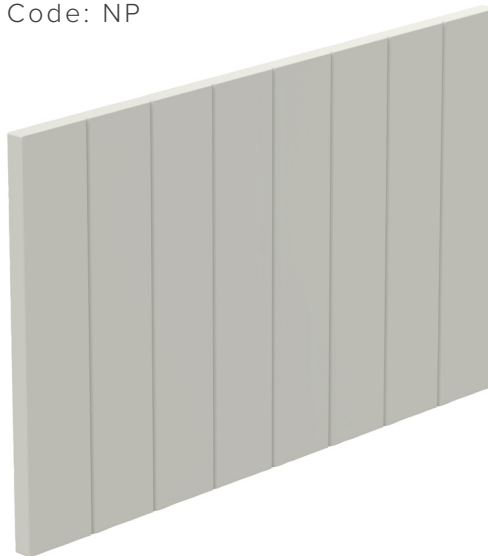

Seafoam

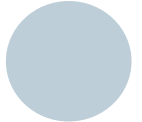

Iceberg

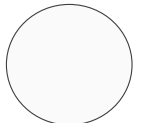

Snow White



Cherry Blossom



Slate Grey



Dusk Grey



Indigo



Matte Black