

SPECIFICATION SHEET

Skye 750mm 1 Drawer Wall Vanity



Features

- Wall Hung
- Full Extension Soft Close Drawer
- Cabinet:
White - 2-Pack Urethane on MRF
Colour - Laminate Finish
- Slab Top Options:
20mm Quartz Top or StoneCast Top
- Dimensions: H420 x W750 x D465

*Note: Vessel basins are purchased separately.
Visit www.newtech.co.nz for full range of vessel basin options.*

Cabinet Options



Winter Birch
97475WB



Nordic Ash
97475NA



Californian Oak
97475CA

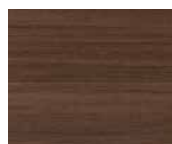

Sweet Maple
97475SM



Roasted Walnut
97475RN

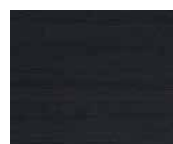

Charred Elm
97475CE

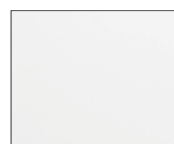

Gloss White
97475GW

StoneCast Slab Top Options

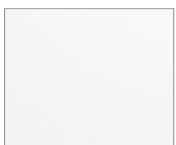

Gloss White
SC

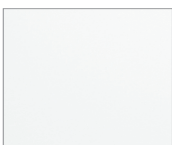

Matte White
SCMW

Quartz Slab Top Options

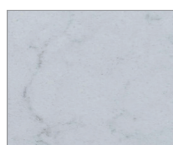

Himalaya
HY

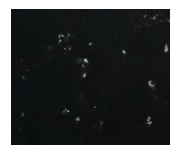

Midnight Stone
MS

Note: To order a Slab Top, add the slab top code to the cabinet code.

Technical Details

Note: All measurements shown are in millimetres. Sizes are nominal.

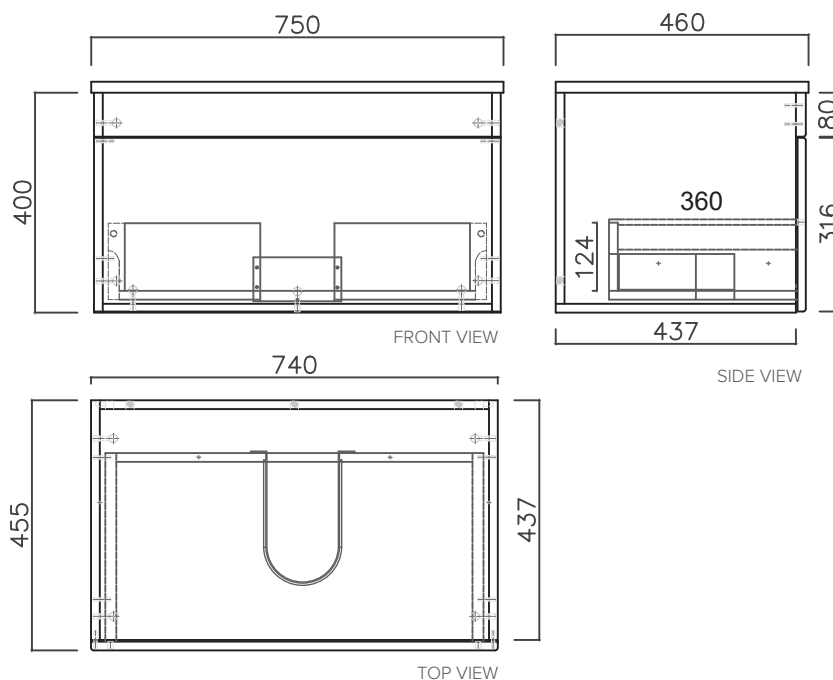

SPECIFICATION SHEET

Slab Top Options

StoneCast Slab Top 750

W750 x D465 x H20

Gloss White - SC

Matte White - SCMW

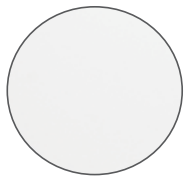
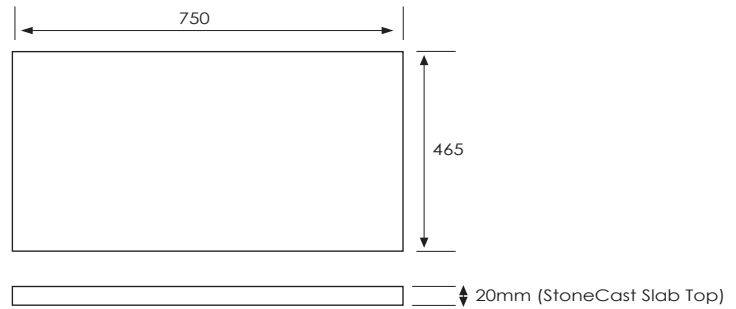
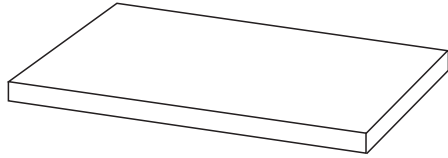

Gloss White

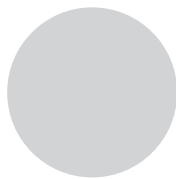

Matte White

Quartz Slab Top 750

W750 x D465 x H20

Midnight Stone - MS

Himalaya - HY

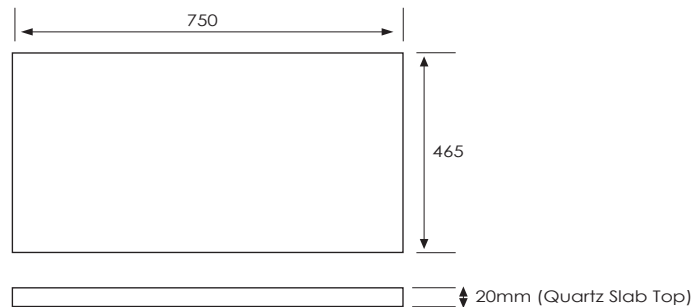
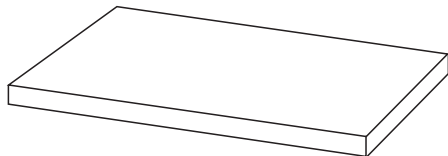

Midnight Stone

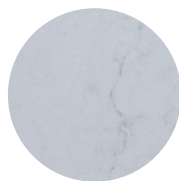

Himalaya

Tap Hole Position

Tap hole position must be specified

- NTH** No Tap Holes
- CTH** Centre Tap Holes
- LTH** Left Tap Holes
- RTH** Right Tap Holes
- ITH*** Inside Tap Holes
- OTH*** Outside Tap Holes

*only applicable with double basins