

Cangas

vcbc

DESCRIPTION

Cangas 800 Wall-Hung Vanity - 2 Drawers, White / Melamine

PRODUCT CODE

CAD80D2WH /
CAD80D2WHM



FEATURES

- Dimensions: W805 x H638 x D455 mm
- Available in 2 drawer/single bowl, widths: 600, 800, 1000, 1200mm and 4 drawer/double bowl, widths: 1200 & 1400mm.
- Ceramic top with overflow from Europe.
- Available in White or Melamine.
- White Paint - The paint used on our products is polyurethane or UV based. It is five times harder and more durable than lacquer finishes.
- Melamine - Our wood grain melamine is a low-pressure laminate.*
- Soft-close drawers. New drawer heights offer storage variations.
- Rail options include Silver or Black Aluminium rail. Semi handle (H2) available at an additional cost.

PAINT / MELAMINE FINISHES*



White Paint



Nordic Ash

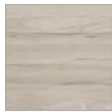

Driftwood

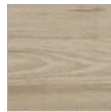

French Oak



Manhattan
Elm



Southern
Oak



Charred
Oak

NOTES

*Non-stock item.

Excludes tap ware & accessories. See reverse page for technical drawings.

MICHEL CÉSAR
VCBC
BURLINGTON
LAUNDRY

/ WHERE BATHROOMS
& LAUNDRIES
COME TOGETHER
BEAUTIFULLY /

info@smail.co.nz
bathco.co.nz

4-8 Ace Place
Kingsland
Auckland 1021
New Zealand

P +64 9 309 9109
F +64 9 309 9343

86 Wigram Road
P.O. Box 8644
Christchurch 8025
New Zealand

P +64 3 343 0969
F +64 3 343 0967

BATH/
CO/

DESCRIPTION

Cangas 800 Wall-Hung Vanity - 2 Drawers, White / Melamine

PRODUCT CODE

CAD80D2WH /
CAD80D2WHM

TECHNICAL DRAWINGS

Top

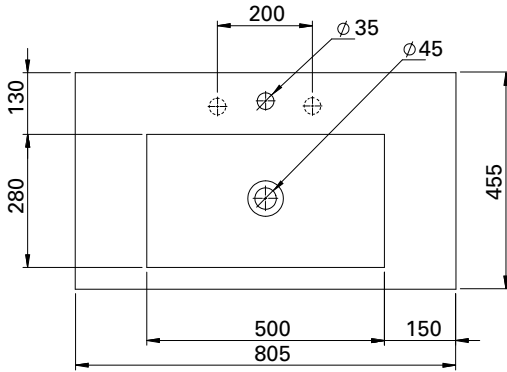

Side Section of Basin (AA)

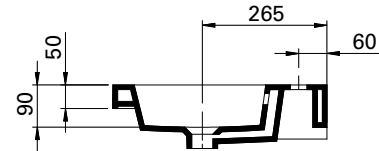

Front

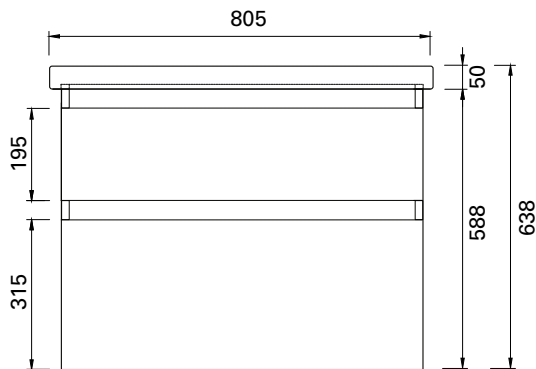

Side

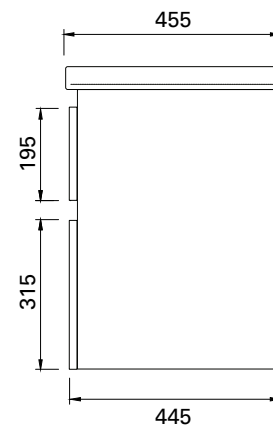

Back of Basin

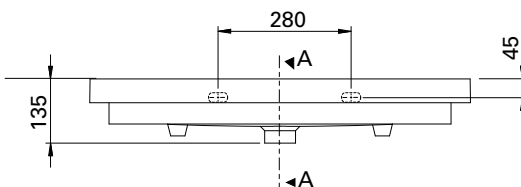

NOTES

Drawing indicates the technical measurement only and is not a reflection of how the unit will look. Sizes are nominal only. All drawings in millimeters. Drawings not to scale.