

DOUBLE DRAWER

EDGE.

EG120D2 /T

Michel César



Product Feature

- + Paint — The paint used on our products is polyurethane or UV based. It is five times harder and more durable than lacquer finishes. Hundreds of gloss colour options available.
- + Timber finishes — Our timber finishes are available in Dark Oak, Natural Oak, White Oak, Walnut, Noce, Chestnut and Tussock. Being 100% natural products, each will have variations in grain and colour. All come stained and sealed with a protective UV finish. Gloss option is available for most veneers.

Vanity Finishes

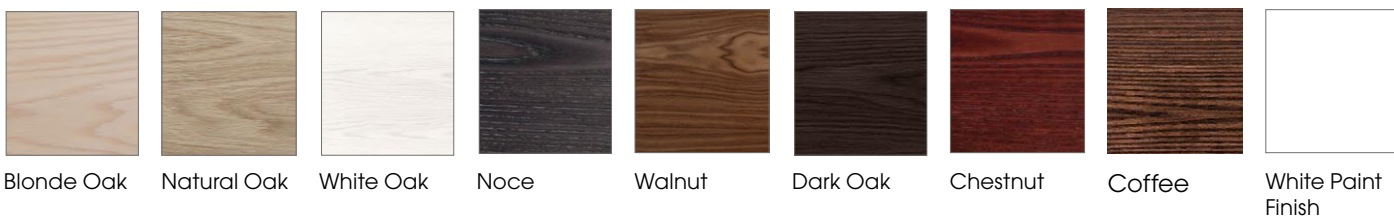

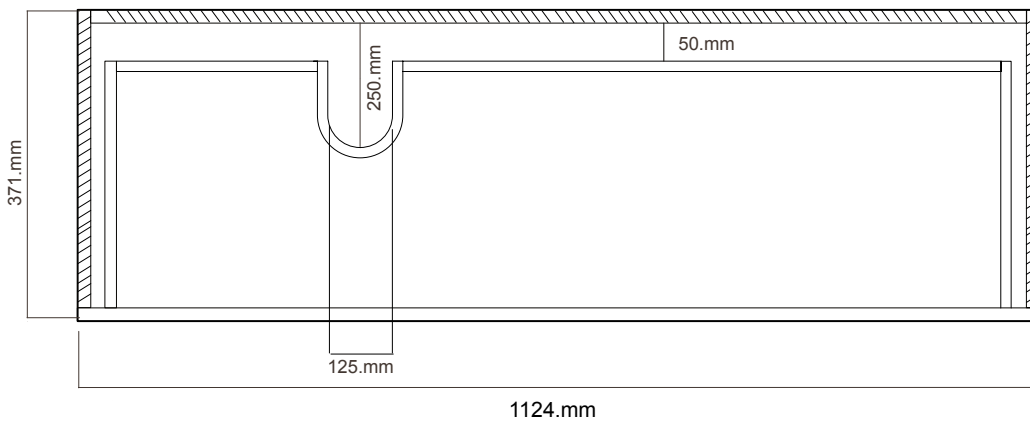
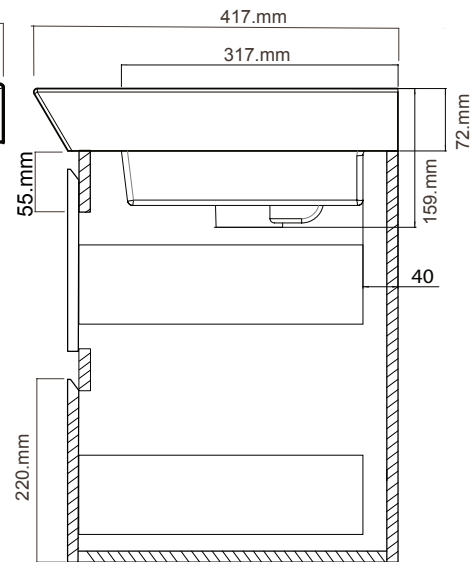
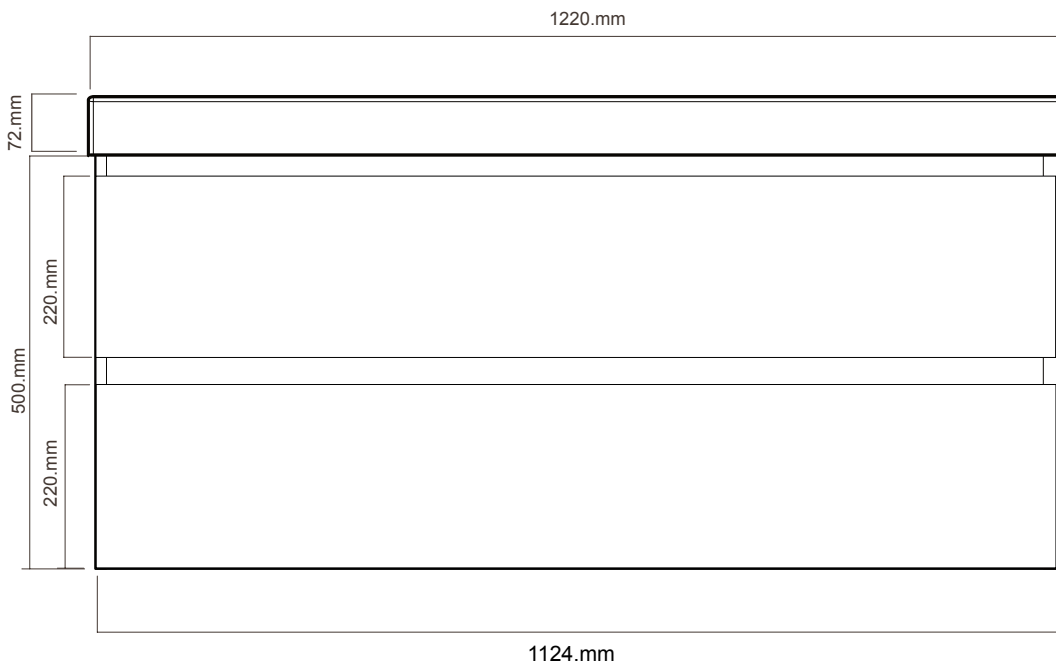
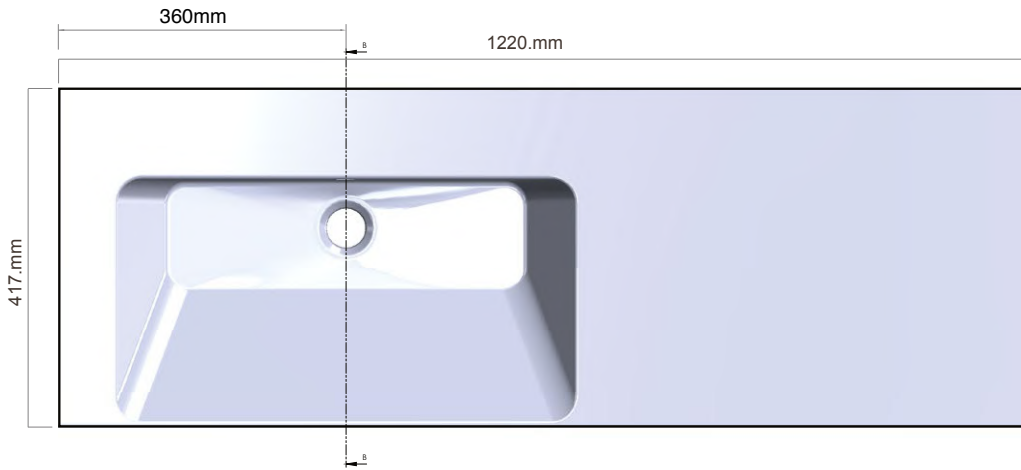

DOUBLE DRAWER

EDGE.

EG120D2LH/EG120D2TLH
2 Drawers, White/Timber

Note: Drawing indicate the technical measurement only and is not a reflection of how the unit will look.