

English Classic

vcbc

DESCRIPTION

English Classic 600 Floor Standing Vanity – 2 Drawer, Matt White

PRODUCT CODE

ENG60D2



FEATURES

- Dimensions: W600 x H892 x D485 mm
- Available in widths 600, 700, 800 and 1000mm (single bowl) – wall-hung or floor standing. Also available as a wall-hung cupboard.
- Ceramic top with overflow from Europe.
- Available in Satin White – The paint used on our products is polyurethane or UV based. It is five times harder and more durable than lacquer finishes.
- Soft-close drawers. New drawer heights offer storage variations.
- Chrome handles.
- Cabinet features Edwardian details.
- Cabinetry made in New Zealand.
- Pair with the Burlington range of tapware and accessories.*

PAINT FINISH*



Matt White

NOTES

*Non-stock item. Excludes tap ware & accessories. See reverse page for technical drawings.

MICHEL CÉSAR
VCBC
BURLINGTON
LAUNDRY

/ WHERE BATHROOMS
& LAUNDRIES
COME TOGETHER
BEAUTIFULLY /

info@smail.co.nz
bathco.co.nz

4-8 Ace Place
Kingsland
Auckland 1021
New Zealand

P +64 9 309 9109
F +64 9 309 9343

86 Wigram Road
P.O. Box 8644
Christchurch 8025
New Zealand

P +64 3 343 0969
F +64 3 343 0967

BATH/
CO/

English Classic

vcbc

DESCRIPTION

English Classic 600 Floor Standing Vanity – 2 Drawer, Matt White

PRODUCT CODE

ENG60D2

TECHNICAL DRAWINGS

Top

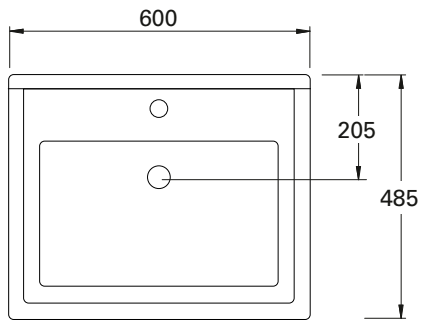

Back of Basin

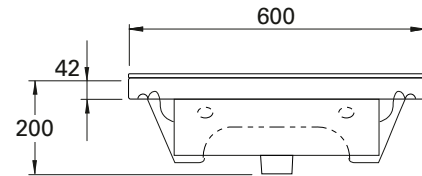

Front

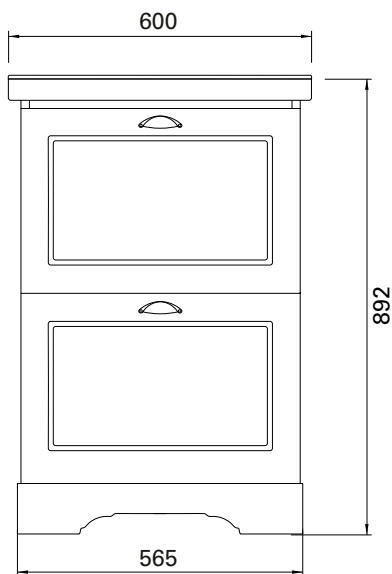

Side

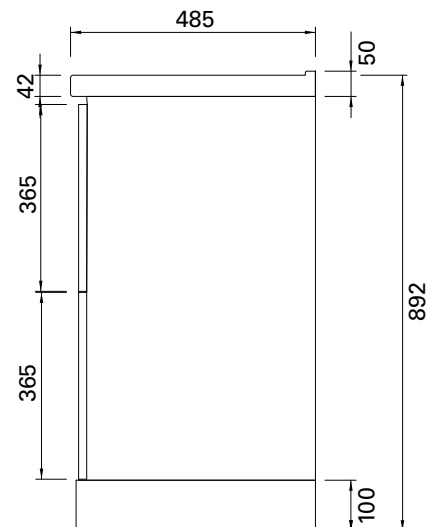

NOTES

Drawing indicates the technical measurement only and is not a reflection of how the unit will look. Sizes are nominal only. All drawings in millimeters. Drawings not to scale.