

REV	DESCRIPTION	DATE	BY	ECA
-----	-------------	------	----	-----

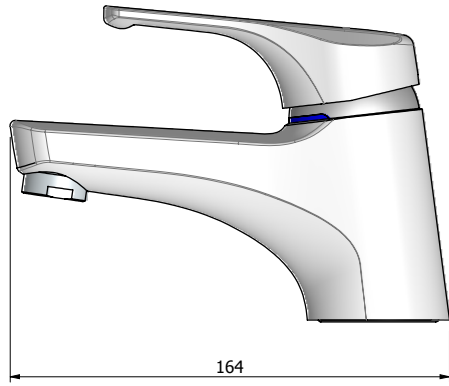

SP334

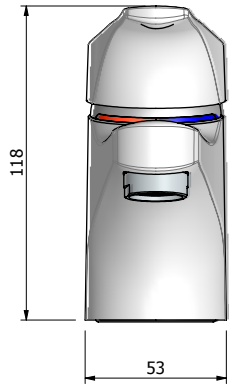

SP233550



SP465



SP033550

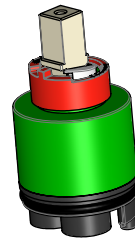

SP143

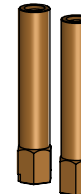
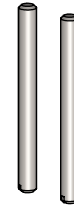

785946

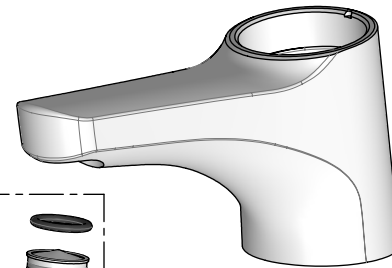

782002

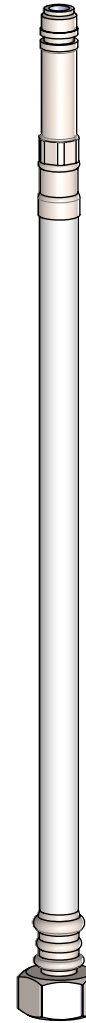

782002

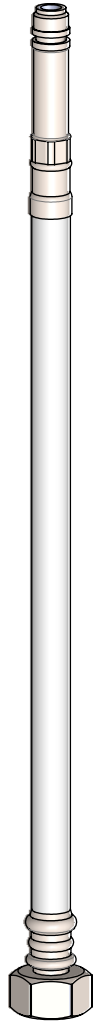

BANKAS_PRODUCED_TFW_04

Process Control Notes:

- = Significant Characteristics
- = Customer Significant Features
- = Safety Critical Features

All identified features are required to be produced with a process Cpk ≥ 1.33

Dimensions in mm



Scale: 1:2

DO NOT SCALE

TOLERANCES UNLESS SPECIFIED OTHERWISE

LINEAR	ANGLES ± 3°
0 ± 0.4	SURFACE FINISH: 1.6/
0.0 ± 0.2	0.00 ± 0.1

CONCENTRICITY © 0.1 ALL Ø ABOUT COMMON CENTRELINE

DRAWN: C Bauer
14/07/2016

MATERIAL: Refer parts

COLOUR: Specify

DESCRIPTION: **BASIN MIXER FUTURA CP - SP**

CHECKED: Select checked by

MASS: 2200 g

FINISH: Specify

mETHVEN LIMITED
Private Bag 19996, Auckland 1746
447 Rosebank Road, Avondale,
Auckland 1026
PH (+649) 829-0429 FAX (+649) 829-0439

Sheet 1 of 1

Sheet size A3

DWG. No

FT2050CP

REV **A**