

FUTURA BATH FAUCET

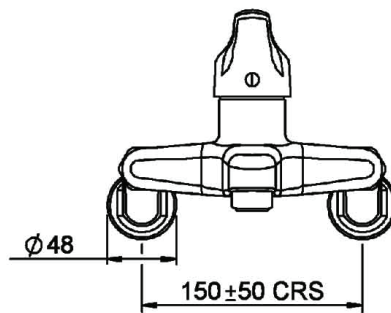
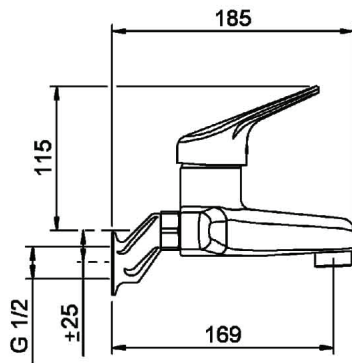

CONSTRUCTION: Brass body

CARTRIDGE TYPE: Ceramic (SP033550)

CLASSIFICATION: Suitable for all pressure systems

INLET CONNECTIONS: 1/2" BSP Female

WORKING PRESSURE: 35 - 1000kPa

DIMENSIONS FOR FITTING: 150±50mm distance between connectors

OPERATING TEMPERATURE: 5 °C - 80 °C

WATER FLOW RATE: 12.0 l/m

- Supplied with aerator and flow director for spout outlet
- Removable flow restrictor on cold inlet
- 30mm extension available
- New handle design

FU2080CP2

Chrome

<http://www.methven.com/nz/futura-bath-mixer>