

INSTALLATION INSTRUCTIONS

COMO WALL MOUNT MIXER | C1700

progetto
DESIGN COLLECTION

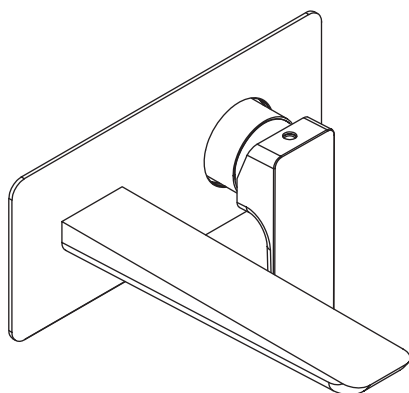

IMPORTANT!

Please read these instructions **prior** to installation

Distributed by:

Plumline

T 04 568 9898 E sales@plumline.co.nz
www.plumline.co.nz

RECOMMENDATIONS FOR INSTALLATION



ATTENTION: Failure to follow these recommendations may void the warranty. It is recommended that a qualified, licensed tradesperson install this product.

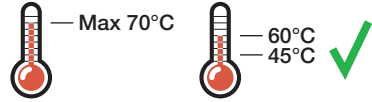
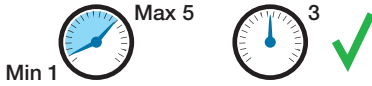

Water Pressure: 3 bar

Product performance cannot be guaranteed if pressure is less than 1 bar. Above 5 bar a pressure regulator must be installed. Failure to do so voids the product warranty.

Water Temperature: 45°-65°C

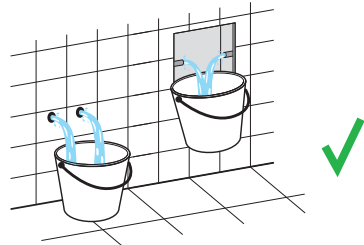
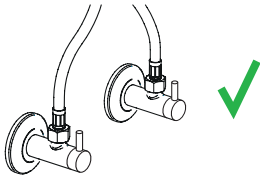

Stop Taps/Filters

Angle valves and/or filters are recommended to prevent impurities and debris entering the mixer.

Pre-Flush

Always flush out the pipework before connecting any tapware. Failure to do so voids the product warranty.

CLEANING & MAINTENANCE

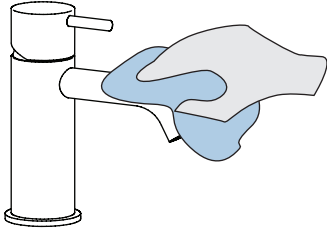

Cleaning

Clean with warm soapy water and a smooth cloth. Avoid abrasive sponges or detergents as these will damage the finish.

To preserve the finish it is recommended to apply a stainless steel oil/mineral oil on a monthly basis.

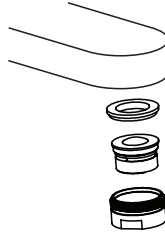

Aerator Maintenance

Remove the aerator, either with a spanner or an aerator cartridge key.

Immerse for half a day in water-vinegar solution (80-20%).

Wash, then reassemble.

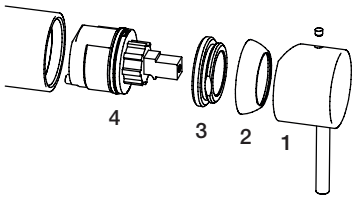

Cartridge Replacement

Before you start, turn off the water supply to the mixer.

1. Remove the handle
2. Unscrew the dome (hand tightened)
3. Unscrew the locking nut
4. Remove the cartridge

Re-assemble in reverse order

 Max tightening torque on locking nut: 10-12 Nm

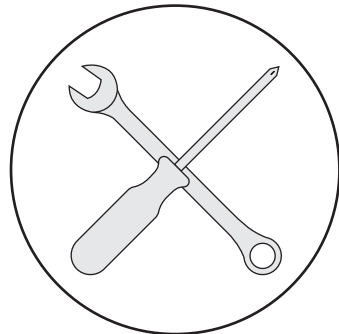

Warranty Information

For full details about our warranty visit plumbline.co.nz/warranty-information

BEFORE WALL LINING

- 1 When preparing the wall for pipework and suitable fixing points for the mixer body, ensure that the finished wall surface is within the minimum/maximum parameters shown on the protective sleeve.

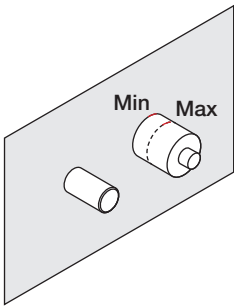

- 2 Connect the hot & cold water inlet pipes.

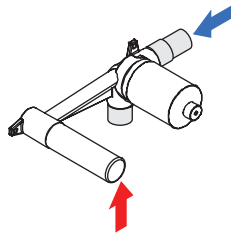

- 3 Fasten the mixer body to the wall, ensuring that it is level.

- Pressure test the unit before wall lining to ensure there are no leaks.

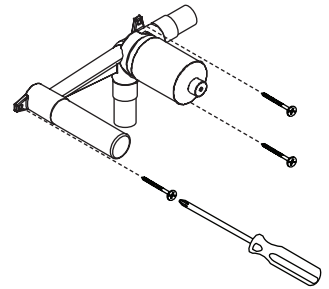

AFTER WALL LINING

- 4 Remove the protective sleeves.

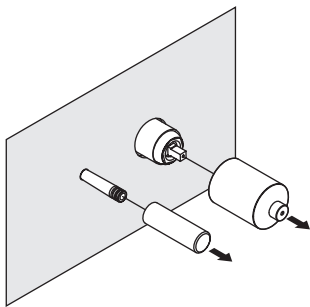

- 5 Fasten the spout to the backplate using the screws provided.

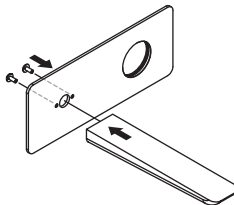

- 6 Install the backplate/spout assembly and the handle. It is recommended to apply a small bead of silicone behind the backplate to prevent water entering the wall cavity.

