

# Owner's **Guide** and Installation Instructions



## Gas Continuous Flow Water Heater

27L Gas Water Heater — 874 & 872 Series, 627 Models

This water heater must be installed and serviced by an authorised person.  
Please leave this guide with the householder.



---

**⚠ Warning:** Upon completion of the installation and commissioning of the water heater, leave this guide with the householder or a responsible officer. **DO NOT** leave this guide inside of the cover of the water heater, as it may interfere with the safe operation of the water heater or ignite when the water heater is turned on.

---

#### **PATENTS**

This water heater may be protected by one or more patents or registered designs in the name of Rheem Australia Pty Ltd or Paloma Co., Ltd.

Rheem New Zealand Pty Ltd is the supplier of the Rheem range of electronic continuous flow gas water heaters, manufactured by Paloma Co., Ltd, a world leader in water heater technology and manufacture.

#### **TRADEMARKS**

® Registered trademark of Rheem New Zealand Pty Ltd.

™ Trademark of Rheem New Zealand Pty Ltd.

**Note:** Every care has been taken to ensure accuracy in preparation of this publication. No liability can be accepted for any consequences, which may arise as a result of its application.

---

# CONTENTS

---

**HOUSEHOLDER - We recommend you read pages 4 to 41.**  
The other pages are intended for the installer but may be of interest.

<b>Contents .....</b>	<b>3</b>
<b>About Your Water Heater .....</b>	<b>4</b>
<b>Temperature Control .....</b>	<b>9</b>
<b>Temperature Control – Standard .....</b>	<b>10</b>
<b>Temperature Control – Deluxe .....</b>	<b>20</b>
<b>Save A Service Call .....</b>	<b>39</b>
<b>Installation – Water Heater .....</b>	<b>42</b>
<b>Connections – Electrical.....</b>	<b>55</b>
<b>Ez-Link System Dual Installation .....</b>	<b>56</b>
<b>Installation – Controllers .....</b>	<b>60</b>
<b>Commissioning.....</b>	<b>67</b>
<b>Draining The Water Heater .....</b>	<b>74</b>
<b>Water Supplies.....</b>	<b>74</b>
<b>Warranty .....</b>	<b>75</b>
<b>Water Quality .....</b>	<b>75</b>

---

## ABOUT YOUR WATER HEATER

---

### MODEL TYPE

The Rheem® electronic continuous flow gas water heater model you have chosen is for outdoor installation only. This model has an extended warranty (refer to “Warranty” on page 75).

The water heater has a factory preset outlet temperature setting of:

- 874 series 55°C
- 872 series 55°C

### Notes:

- The 874 series water heater may be installed as an in-series gas booster water heater to a solar preheat water heater. For information relating to the function and operation of the solar water heater, refer to the Owner's Guide and Installation Instructions supplied with the solar water heater.
- When installed as a gas booster to a solar preheater, the 874 series water heater:
  - Can deliver water at temperatures up to 75°C for a Premier Loline system.
  - During periods of low solar energy gain, will boost the water temperature automatically to a minimum 75°C when required.
- The 872 and 874 series water heaters can be used on a recirculation system.
- The 872 series water heater can be preset to a maximum temperature of 82°C.

### WATER HEATER OPERATION

The water heater operates automatically, heating water as it passes through the water heater. When a hot tap is opened, the gas burners ignite to provide immediate heating of the water. The heat produced by the burner is transferred to the water through the heat exchanger. The water is heated to a constant temperature by the automatic adjustment of the gas supply to the burner to suit the water flow rate (refer to “Temperature Control” on pages 9 to 38). The gas burners extinguish when the hot tap is closed.

Automatic safety controls are fitted to the water heater to provide safe and efficient operation.

### GAS BOOSTING FOR A SOLAR WATER HEATER

Water stored in the solar storage tank passes through the gas booster water heater when a hot tap is opened. The gas booster water heater is for heating water at times of low solar energy gain, such as during cloudy or rainy weather, or during winter months.

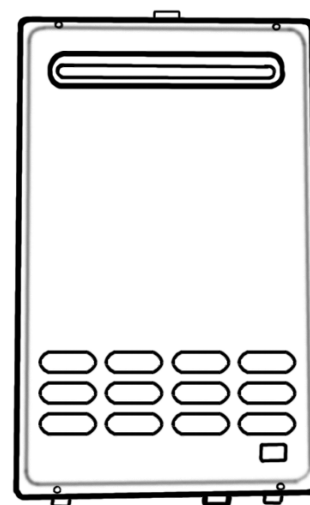

### 874 SERIES

Solar heated water can reach temperatures up to 75°C for a Premier Loline system. The gas booster water heater operates automatically. When the solar heated water temperature is 58°C or higher, the flow passes through the gas booster water heater without boosting. When the solar heated water temperature is below 58°C, the gas booster water heater operates, and heats the water to a minimum temperature of 75°C.

### 862 SERIES

When the gas booster is set at temperatures up to 75°C and the water from a solar preheat is within 2°C of the gas booster set temperature, the incoming flow passes through the in-series gas booster without operating. If the water heater is set at 82°C the temperature difference before the gas booster operates increases to 4°C below the set temperature. (i.e. incoming water temperature is <78°C)

**MAINS PRESSURE**

The water heater is designed for direct connection to the mains water supply. If the mains supply pressure in your area exceeds that [shown on page 44](#), a pressure limiting valve must be fitted. The supply pressure should be greater than 140 kPa for the rated flow and performance to be achieved.

**HOW HOT SHOULD THE WATER BE?**

The water heater may be installed with one or more user adjustable temperature controllers, which allow you to choose the most suitable temperature for your hot water needs (refer to [“Temperature Control”](#) on page 9).

If a controller is not installed, the water heater heats the water to the factory preset outlet temperature setting.

The preset outlet temperature setting is:

- 874 series      55°C
- 872 series      55°C

**Note:** The preset outlet temperature setting of this water heater cannot be adjusted by the householder. The setting can only be adjusted by the installer, or a Rheem Service Centre.

If this water heater is installed as part of a solar water heater system, the installer has checked and if required, adjusted the preset outlet temperature setting to:

- 864 series      75°C
- 862 Series      70°C

A tempering valve **must** be installed as per AS/NZS3500.4 requires you to do so.

**⚠ Warning:** Temperature controllers **must not** be fitted to this water heater (874 series) as part of a solar water heater system. This is because the water can be supplied at a temperature much higher than the controller temperature setting. If a solar preheater has been installed to an existing water heater installation, then all controllers **must be** disconnected and removed.

If this water heater is installed as part of a solar water heater system, the system can deliver water at temperatures from 58°C up to 75°C and possibly higher depending upon the model of solar water heater installed.

**HOTTER WATER INCREASES THE RISK OF SCALD INJURY**

This water heater can deliver water at temperatures which can cause scalding. Check the water temperature before use, such as when entering a shower or filling a bath or basin, to ensure it is suitable for the application and will not cause scald injury.

The factory preset temperature setting of an 874 and 872 series water heaters will not deliver temperatures exceeding 55°C. There is no requirement in AS/NZS 3500.4 to fit a temperature limiting device unless the water heater is supplying hot water to an early childhood centre, school, nursing home or a facility for young, aged, sick or disabled people.

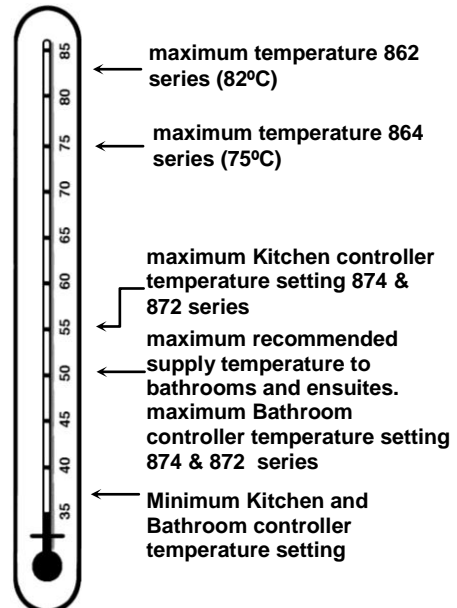

**⚠ WARNING**

This water heater is only intended to be operated by persons who have the experience or the knowledge and the capabilities to do so. This water heater is not intended to be operated by persons with reduced physical, sensory or mental capabilities i.e. the infirm, or by children. Children should be supervised to ensure they do not interfere with the water heater.

The water heater uses 240 Volt AC electrical power for operation of the control systems and the combustion fan. The removal of the front panel will expose 240 V wiring. It must only be removed by an authorised or qualified person.

The power lead from the water heater must be plugged into a weatherproof electrical outlet. Take care not to touch the power plug with wet hands.

**SAFETY**

This water heater is supplied with temperature sensors, a FlameSafe® protection system and a pressure relief valve. These devices must not be tampered with or removed. The water heater must not be operated unless each of these devices is fitted and is in working order.

If the power supply cord or plug is damaged, it must be replaced by an authorised person in order to avoid a hazard. The power supply cord and plug must be replaced with a genuine replacement part available from Rheem. Phone your nearest Rheem Service Centre to arrange for an inspection.

**The warranty can become void if relief valves or other safety devices are tampered with or if the installation is not in accordance with these instructions.**

- Do not store **flammable or combustible materials** near the water heater. Flammable liquids (such as petrol), newspapers and similar articles must be kept well away from the water heater and the flue terminal.
- Do not use **aerosols, stain removers and household chemicals** near the water heater whilst it is working. Gases from some aerosol sprays, stain removers and household chemicals become corrosive when drawn into a flame.
- Do not store **swimming pool chemicals, household cleaners**, etc., near the water heater.
- Do not place anything on top of the water heater or in contact with the flue terminal. Ensure the flue terminal is not obstructed in any way at any time.



**GOING ON HOLIDAYS**

If you are going on holidays, it is not necessary to turn the water heater off. If it is necessary to turn off the water heater, refer to [“To Turn off the Water Heater”](#) on page 7.

### TO TURN OFF THE WATER HEATER

If it is necessary to turn off the water heater:

- Turn off the controller(s) (if fitted) by pressing the on / off button.  
The light in the on / off button will go out and the priority light (standard controller) or the ACTIVE light (Deluxe controller), if it is on, will go out.
- Switch off the electrical supply at the power outlet to the water heater if there is no risk of freezing conditions occurring (refer to note below).
- Close the gas isolation valve at the inlet to the water heater.
- Close the cold water isolation valve at the inlet to the water heater.

**Note:** If there is a risk of freezing conditions, the electrical supply to the water heater should not be switched off unless the water heater is drained, otherwise damage could result (refer to “[Frost Protection](#)” on page 8 and “[Draining the Water Heater](#)” on page 8).

### TO TURN ON THE WATER HEATER

- Screw in the drain plugs at the cold water inlet and hot water outlet of the water heater if the water heater has been drained.
- Open all of the hot taps in the house (don't forget the shower).
- Open the cold water isolation valve fully at the inlet to the water heater.  
Air will be forced out of the taps.
- Close each tap as water flows freely from it.
- Open the gas isolation valve fully at the inlet to the water heater.
- Plug in the power supply cord at the power outlet.
- Switch on the electrical supply at the power outlet to the water heater.
- Turn on a controller, if one is fitted, by pressing the on / off button.  
The light in the on / off button and the priority light (standard controller) or ACTIVE light (Deluxe controller) will both glow.

The water heater will operate automatically when you open a hot tap.

### HOW DO I KNOW IF THE WATER HEATER IS INSTALLED CORRECTLY?

Installation requirements are [shown on page 52](#). The water heater must be installed by an authorised person. In New Zealand, the installation must comply with Standards AS/NZS 3500.4, NZS 5261 or AS/NZS 5601 and all local codes and regulatory authority requirements.

**⚠ Warning:** Temperature controllers **must not** be fitted to this water heater (874 series) as part of a solar water heater system because water at a temperature much higher than the controller setting can be delivered. If a solar preheater has been installed to an existing water heater installation, then all controllers **must be** disconnected and removed.

The pipe work between the solar storage tank (if one is installed) and the gas booster water heater has a minimum recommended pipe size of DN20, **MUST BE** of copper and be fully insulated in accordance with the requirements of AS/NZS 3500.4. The insulation must be weatherproof and UV resistant if exposed. The insulation must be fitted up to the connections on both the solar storage tank and the gas booster water heater.

### DOES THE WATER CHEMISTRY AFFECT THE WATER HEATER?

The water heater is suitable for most public water supplies; however some water chemistries may have detrimental effects on the heat exchanger and fittings. **If you are in a known harsh water area you must read page 74.** If you are not sure, have your water chemistry checked against the conditions [described on page 74](#).

### HOW LONG WILL THE WATER HEATER LAST?

There are a number of factors that will affect the length of service the water heater will provide. These include the water chemistry, the water pressure, temperature (inlet and outlet) and the water usage pattern. However, your water heater is supported by a comprehensive warranty (refer to page 75).

### GENERAL MAINTENANCE

The jacket of the water heater can be cleaned with a soft cloth and warm mild soapy water. Under no circumstances should abrasive materials or powders be used.

### SERVICING

For safe and efficient operation, the water heater should be serviced annually by your nearest Rheem Service Centre. Only genuine replacement parts should be used on this water heater.

**⚠ Warning:** Servicing of a gas water heater should only be carried out by authorised personnel.

### FROST PROTECTION

The water heater has a frost protection system. The frost protection system will protect the water heater from damage, by preventing ice forming in the waterways of the water heater, in the event of freezing conditions occurring.

#### Notes:

- The frost protection system will be rendered inoperable if electrical power is not available at the water heater. Damage caused by freezing due to the unavailability of power at the water heater is not covered by warranty (refer to [“Warranty Exclusions”](#) on page 76).
- If it is necessary to switch the power off to the water heater and there is a risk of freezing, then it is necessary to drain the water heater (to [“Draining the Water Heater”](#) on page 74).
- Pipe work to and from the water heater must be adequately insulated to prevent freezing.
- The water heater is not suitable for installation in areas where the ambient temperature falls below -20°C (including wind chill factor).
- Refer to [“Warranty Exclusions”](#) on page 76.

### DRAINING THE WATER HEATER

- Turn off the water heater (refer to [“Turn Off The Water Heater”](#) on page 73).
- Open a hot tap (preferably the shower outlet).
- Unscrew the two drain plugs, one each at the cold water inlet and hot water outlet, on the underside of the water heater.

Water will drain from the water heater.

- When water stops flowing from the water heater, close the hot tap.

**Note:** It is recommended not to screw the drain plugs back in, until the water heater is to be turned on again.

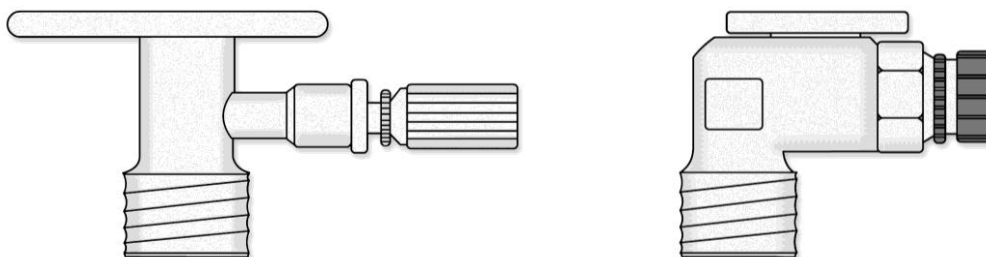



---

# TEMPERATURE CONTROL

---

## **NOTE: CONTROLLERS MUST NOT FITTED IF WATER TEMPERATURES ABOVE 55°C ARE REQUIRED CONTROLLERS**

The Rheem 874 and 872 series can be installed with Rheem controllers to enable the user to control the temperature of the delivered water from the outlet of the water heater. There are two families of Rheem controllers suitable for installation with this water heater. These are the standard controllers and the Deluxe controllers.

### **Standard Controllers**

There are three types of standard controller. They are the Kitchen controller (Rheem PN A299850), Bathroom1 controller (Rheem PN A299851) and the Bathroom2 controller (Rheem PN A299852). The standard controllers are suitable for use on all 874 and 872 series water heaters.

The standard controllers are identified by a 'K' (Kitchen controller), 'B1' (Bathroom1 controller) or 'B2' (Bathroom2 controller) located on the front bottom left hand corner of the standard controller.

### **Deluxe Controllers**

There are three types of Deluxe controller. They are the Kitchen Deluxe controller (Rheem PN A299861), Bathroom1 Deluxe controller (Rheem PN A299862) and the Bathroom2 Deluxe controller (Rheem PN A299863).

The Deluxe controllers are identified by a 'K' (Kitchen Deluxe controller), 'B1' (Bathroom1 Deluxe controller) or 'B2' (Bathroom2 Deluxe controller), located under the front panel, to the bottom left hand corner adjacent to the BATH FILL VOLUME label.

The Deluxe controllers offer additional functions to the standard controllers. These are:

- An assistance call function, which provides a voice prompt when pressed and will sound on all controllers. This is useful should a family member require assistance when in the bathroom.
- A Bath Fill mode, which is designed to allow the water heater to deliver a selected volume of water at a selected temperature. Bath filling takes place when the hot tap is opened. When the set volume has been delivered, the water flow from the water heater ceases. Refer to "[Bath Fill Mode](#)" on page 30.

**Note:** The bath level should be monitored periodically while this function is in use to avoid the possibility of the bath overflowing. The Bath Fill mode should also be used with caution until you are familiar with its operation.

**⚠ Warning:** Baths should not be left unattended whenever young children are present.

**⚠ Warning:** Temperature controllers **must not** be fitted to this water heater (874 series) as part of a solar water heater system. This is because the water can be supplied at a temperature much higher than the controller temperature setting. If a solar preheater has been installed to an existing water heater installation, then all controllers **must be** disconnected and removed.

### **Notes:**

- Where more than one controller is installed, the second or third controller must be of the same family.
- A standard controller can only be installed with another standard controller(s) and a Deluxe controller can only be installed with another Deluxe controller(s). A standard controller(s) and a Deluxe controller(s) cannot be connected to the same water heater.
- One, two or three controllers can be installed. Only one of each type of controller can be connected to the water heater. Therefore, a maximum of three controllers only can be connected to each water heater.
- A Bathroom2 controller can only be installed if a Bathroom1 controller is installed and a Bathroom2 Deluxe controller can only be installed if a Bathroom1 Deluxe controller is installed.
- Other manufacturers' controllers are not suitable to and cannot be installed with this water heater.

---

## TEMPERATURE CONTROL – STANDARD

---

### STANDARD CONTROLLER FUNCTIONS

If one or more controllers are installed, at least one must be on for the water heater to operate. If all controllers are off, the water heater will only deliver cold water.

- on / off** button – This button must be pressed once to turn on the controller.
- A controller cannot be turned on if water is flowing from a hot tap.
- To turn off a controller, press the on / off button once. The light will go out.
- A controller can be turned off whilst water is flowing.
- on / off** operating light – The light in the on / off button will glow when the controller is turned on.
- The light will go out when the controller is turned off.
- priority** light – This light will glow on a controller when that controller has priority.
- The Bathroom controller(s), if they are turned on, have priority over the Kitchen controller.
- Priority means that controller has control of the water heater temperature setting.
- The water temperature setting can only be adjusted by the controller that has priority.
- in use** light – This light will glow on all controllers, whether they are on or off, when hot water is flowing, regardless of which controller has priority.
- display panel** – The current temperature setting is displayed on all controllers (whether hot water is flowing or not), when any controller is on.
- If all controllers are off, then the display remains blank.
- The water volume can also be displayed on the Kitchen controller. The x10/ symbol glows when the water volume is displayed.
- ▲(up** button) – The up button increases the temperature setting (refer to [“Temperature Adjustment – Standard Controller”](#) on page 13).
- ▼(down** button) – The down button decreases the temperature setting (refer to [“Temperature Adjustment – Standard Controller”](#) on page 13).
- water volume** button (Kitchen controller only) – This feature enables an alarm to sound when a set volume of water has flowed through the water heater (refer to [“Water Volume Function – Standard Controller”](#) on page 18).
- water volume** operating light – The light in the water volume button will glow when the water volume button is pressed and the water volume mode is turned on.
- The light will go out when the water volume button is pressed and the water volume mode is turned off.
- water volume** symbol – The x10/ symbol below the display panel glows when the water volume mode is turned on and the water volume is displayed.

## STANDARD CONTROLLER

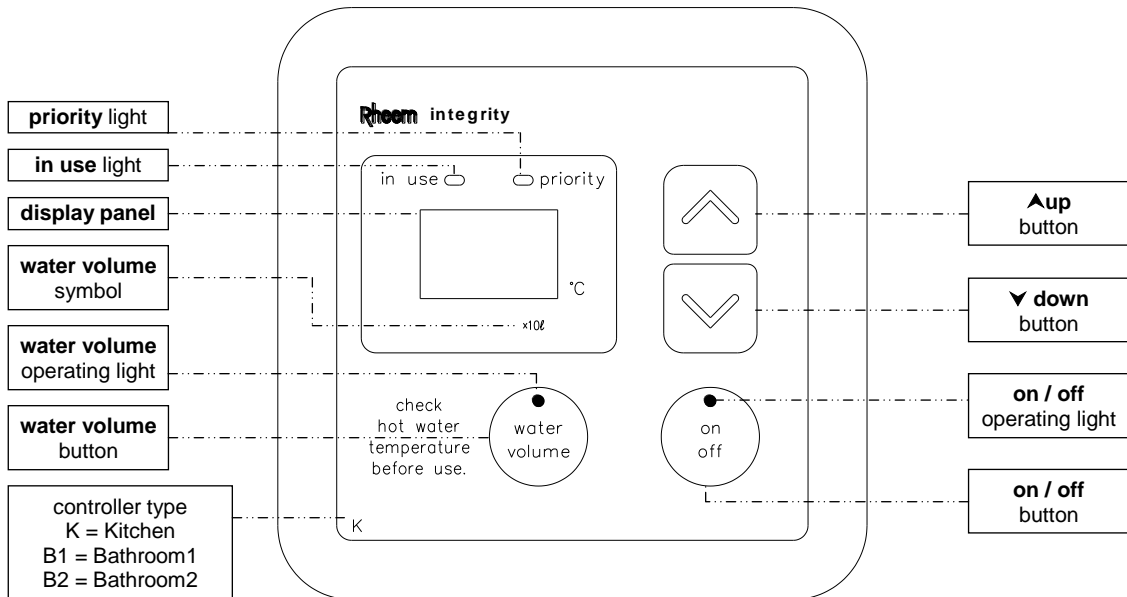

**Note:** **water volume** button, **water volume** operating light and **water volume** symbol are on the Kitchen controller only.

## SILENCING A CONTROLLER – STANDARD

The controller emits a sound whenever a button is pressed. This sound can be turned off to provide silent operation.

To turn off the sound:

- Press the on / off button, to deactivate the controller (on / off light is off).
- Press and hold the up (▲) button.
- Press the on / off button, whilst the up (▲) button is pressed.

The sound for the controller is deactivated. Repeat this procedure on the other controllers if you wish to deactivate their sound. To restore the sound, repeat this procedure.

**TEMPERATURE SETTINGS – STANDARD CONTROLLER**

The temperature settings of each type of controller are:

- Bathroom1 & 2                    37°C to 48°C (in 1°C increments), 50°C
- Kitchen                            37°C to 48°C (in 1°C increments), 50°C\*, 55°C

Temperature settings

37	38	39	40	41	42	43	44	45	46	47	48	50	55
warm			average hot shower					hot			very hot		

The installation of a Bathroom controller(s) only (i.e. no Kitchen controller) limits the temperature setting of the water heater to a maximum of:

- 874 series                        50°C
- 872 series                        50°C

Regardless of the preset outlet temperature setting of the water heater.

The installation of a Kitchen controller will allow a maximum temperature setting of:

- 874 series                        55°C
- 872 series                        55°C

Regardless of the preset outlet temperature setting of the water heater.

If controllers are not installed, the water heater defaults to the factory preset outlet temperature setting in the first instance. This may be changed by the installer up to:

- 874 series                        75°C
- 872 series                        82°C

Refer to [“How Hot Should The Water Be?”](#) on page 5.

If a building is fitted with a temperature limiting device such as a tempering valve and an 874 or 872 series water heater is installed without a separate untempered hot water line to the kitchen, laundry or other non-ablution area. The Kitchen controller will be able to display temperatures up to 55°C, the water leaving the water heater will be at the preset temperature.

However, the maximum water temperature which can be delivered to the hot water outlets in these locations is determined by the preset temperature setting of the temperature limiting device. If fitted, this is usually 55°C, however the temperature setting of the temperature limiting device will determine the outlet temperature.

To enable the delivery of water temperatures above 55°C (e.g. when used as a Solar Booster) no controllers can be fitted to either the 874 or 872 series. The water heater preset temperature will need to be increased by the installer or a suitably qualified person. To supply water above 55°C to the kitchen, laundry or other non-ablution area, a separate untempered supply must be installed from the water heater to the hot water outlets in these locations.

**TEMPERATURE ADJUSTMENT – STANDARD CONTROLLER**

- A controller must be on and have priority to be able to adjust the temperature setting.
- The temperature adjustment is made by pressing the up (▲) button or down (▼) button.
- The maximum temperature setting for the controllers are:

	Kitchen	Bathroom
874 series	55°C	50°C
872 series	55°C	50°C

- Each press of the up (▲) button will increase the temperature setting by one increment.
- Pressing and holding the up (▲) button will scroll the temperature setting up to a maximum 43°C if there is hot water flowing or 45°C if there is no hot water flowing.
- From the 45°C setting, the up (▲) button must be pressed once for each increase in temperature increment.
- The temperature setting cannot be increased above 43°C whilst hot water is flowing.
- The minimum temperature setting for each type of controller is 37°C.
- Each press of the down (▼) button will decrease the temperature setting by one temperature increment.
- Pressing and holding the down (▼) button will scroll down the temperature setting.
- The temperature setting can be decreased from any temperature setting whether the hot water is flowing or not.

### KITCHEN CONTROLLER – STANDARD

The Kitchen controller allows the user to select the temperature setting for the hot water to be used in the kitchen and laundry. It has a minimum temperature setting of 37°C and a maximum temperature setting of:

- 874 series                      55°C
- 872 series                      55°C

The Kitchen controller does not have priority if a Bathroom controller is on.

#### Notes on the Kitchen controller:

- The controller cannot be turned on whilst a hot tap is open.
- The Kitchen controller must be on and have priority in order to adjust the temperature setting on the Kitchen controller.
- The Bathroom controller(s) can be turned off from the Kitchen controller.
  - Press and hold the on / off button on the Kitchen controller for three seconds.  
This turns off all the controllers and the displays go blank.  
If hot water is flowing from a hot tap, it will go cold.

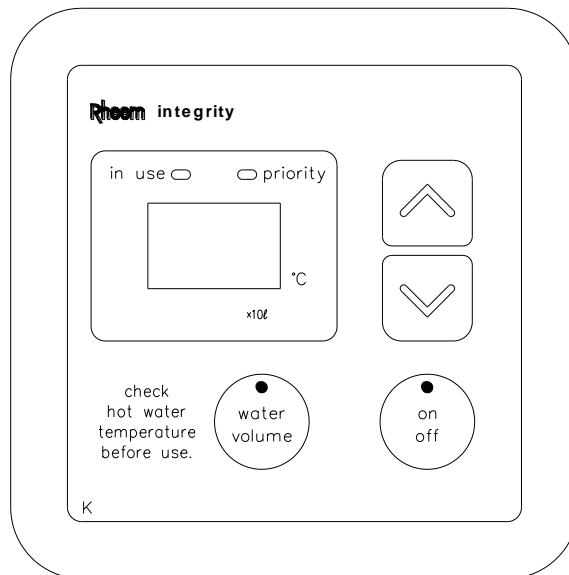

**Kitchen Controller**

To operate the Kitchen controller:

**1. Turn off the Bathroom controller(s)**

- If a temperature setting is displayed and the priority light is not glowing, it is necessary to turn off the Bathroom controller(s) to gain priority.
- Refer to the [notes on the Kitchen controller](#) on page 14.

**2. Turn on the Kitchen controller**

- Press the on / off button.  
The on / off operating light and the priority light will both glow.  
The Kitchen controller temperature setting will be displayed. This is the lower of the previous setting and:
  - ◆ 874 series 50°C
  - ◆ 872 series 50°C

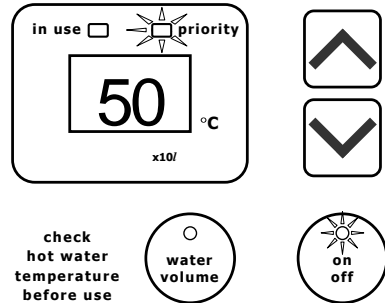

**3. Select the temperature setting**

- Press the up (▲) button or down (▼) button.  
Refer to [“Temperature Adjustment – Standard Controller”](#) on page 13.  
The selected temperature setting will be displayed on all controllers.

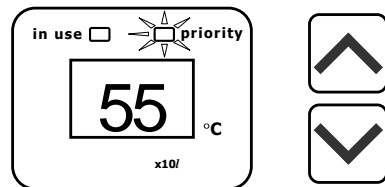

**4. Open the hot tap.**

The in use light will glow on all controllers.

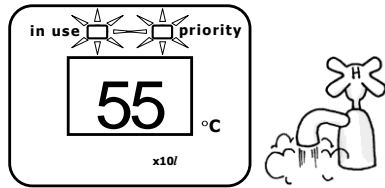

**5. Close the hot tap.**

The in use light will go out on all controllers, if no other hot tap is open.

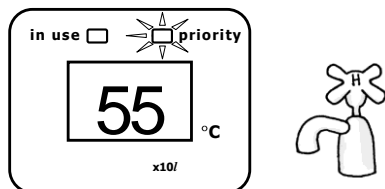

**6. Turn off the Kitchen controller**

- Press the on / off button.  
The priority light and on / off operating light will go out and the temperature display will go blank.

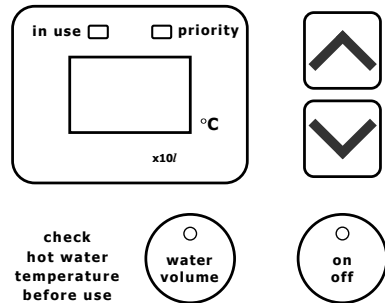

**Important:** Turn off the Kitchen controller after hot water usage is finished in the kitchen and / or laundry. Refer to [Important](#) note for Bathroom controllers on page 16.

**BATHROOM CONTROLLERS – STANDARD**

The Bathroom controller(s) allows the user to select the temperature setting for the hot water to be used in the bathroom. They have a minimum temperature setting of 37°C and a maximum temperature setting of:

- 874 series                                50°C
- 872 series                                50°C

The Bathroom controllers operate in tandem. Whenever an operation is selected on one Bathroom controller, it is also set on the other Bathroom controller. The Bathroom controllers automatically have priority if they are on.

**Important:** It is important to turn on the Bathroom controller before opening a hot tap in the bathroom (priority is automatically gained). If the Bathroom controller is not on and the Kitchen controller is on (has priority), then it is possible to receive water at a temperature higher than expected from a hot tap in the bathroom. This temperature could be up to:

- 874 series                                55°C if a temperature limiting device is installed in the hot pipe to the
- 872 series                                bathroom, or up to 55°C if a temperature limiting device is not installed.

**Notes on the Bathroom controllers:**

- The controller cannot be turned on whilst a hot tap is open.
- When a Bathroom controller is turned on, it gains priority from the Kitchen controller.
- The Bathroom controller must be on in order to adjust the temperature setting on the Bathroom controller.
- The Kitchen controller can be turned off from a Bathroom controller.
  - Press and hold the on / off button on a Bathroom controller for three seconds.
    - This turns off all the controllers and the displays go blank.
    - If hot water is flowing from a hot tap, it will go cold.
- **⚠ Warning:** It is advised to leave the Bathroom controller on after hot water usage is finished in the bathroom. **Turning off a controller in one bathroom will also turn off the controller in the other bathroom.** The Kitchen controller will gain priority if it is on and the temperature setting can be up to:
  - 874 series                                55°C
  - 872 series                                55°C

If a hot tap is open in another bathroom, the water will be delivered at this temperature.

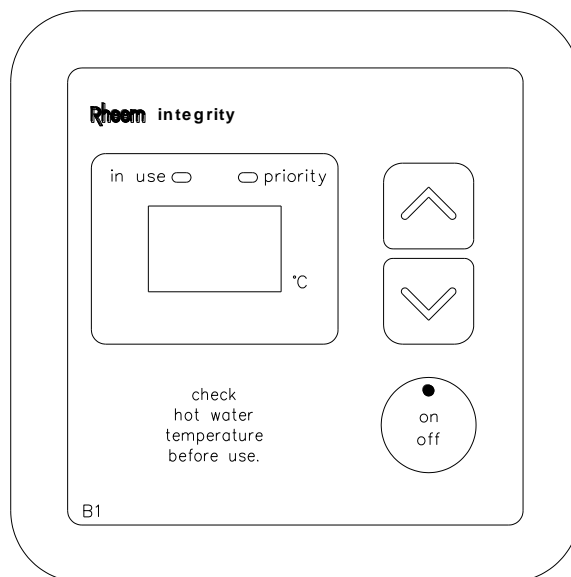

**Bathroom Controller**



To operate a Bathroom controller:

**1. Turn off the Kitchen controller**

- If a temperature setting is displayed and the priority light is not glowing, it is advised to turn off the Kitchen controller.

Refer to the [notes on the Bathroom controllers](#) on page 16.

**2. Turn on the Bathroom controller**

- Press the on / off button.

The on / off operating light and the priority light will both glow.

The temperature setting of 40°C will be displayed.

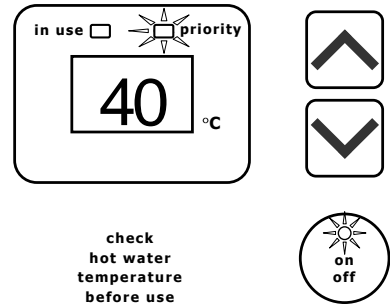

**3. Select the temperature setting**

- Press the up (▲) button or down (▼) button.
- Refer to [“Temperature Adjustment – Standard Controller”](#) on page 13.

The selected temperature setting will be displayed on all controllers.

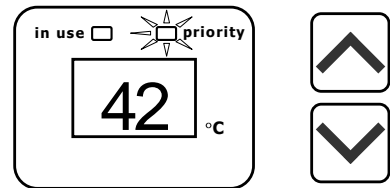

**4. Open the hot tap**

The in use light will glow on all controllers.

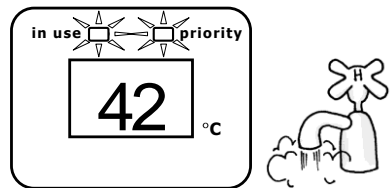

**5. Close the hot tap**

The in use light will go out on all controllers, if no other hot tap is open.

It is advised not to turn off the Bathroom controller(s).

- Refer to the [warning](#) in the notes on page 16.

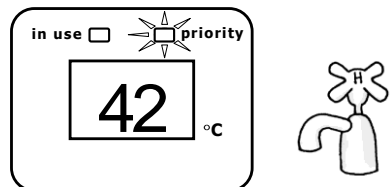

**WATER VOLUME FUNCTION – STANDARD CONTROLLER**

The water volume function is designed to warn, by a beeping sound, that a certain volume of water has been delivered from the water heater. **It does not stop either the flow of or the heating of water.** This function is particularly useful if a bath is being filled, or measuring the water consumed by the use of a shower.

The water volume function can only be set by the Kitchen controller. Refer to the [notes on the water volume function](#) on page 19.

To operate the water volume alarm:

**1. Turn on the water volume alarm**

- Press the water volume button.  
The water volume operating light will glow.  
The current set water volume (in litres divided by 10) will be displayed and the x10l indicator will also glow.  
Eg. The factory preset water volume of 180 litres is shown as 18 x10l.

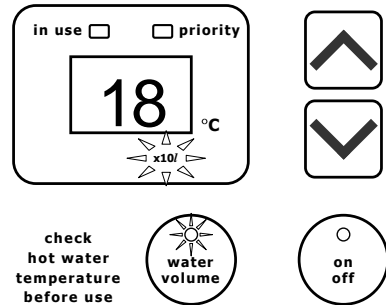

**2. Adjust the water volume setting (if necessary)**

- To adjust the water volume setting, press the up (▲) button to increase the water volume or the down (▼) button to decrease the water volume.  
Each press of the up (▲) button or down (▼) button will change the water volume setting by 10 litres.  
Pressing the up (▲) button or down (▼) button continuously will scroll the water volume setting.  
Fifteen seconds after the water volume has been selected, the water volume operating light will start to flash and the selected water volume is set.

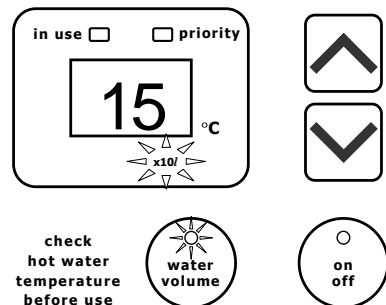

The water volume operating light will continue to flash until the alarm sounds.

A maximum of 500 litres (50 and x10l displayed) and a minimum of 10 litres (1 and x10l displayed) can be set with the water volume alarm.

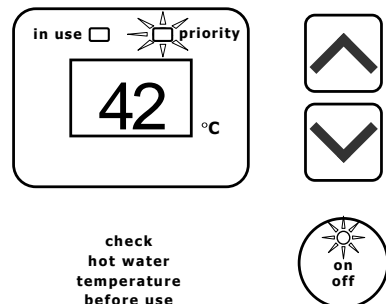

**3. Set the water temperature**

- Turn on the controller for the room where the hot water is to be used.
- Gain priority (if using the Kitchen controller).
- Select the temperature setting.

**4. Open the hot tap**

The in use light will glow on all controllers.  
Measurement of the water flow at the water heater will commence when a hot tap is open and the water volume operating light is flashing.  
The alarm will sound when the set volume of water has passed through the water heater.

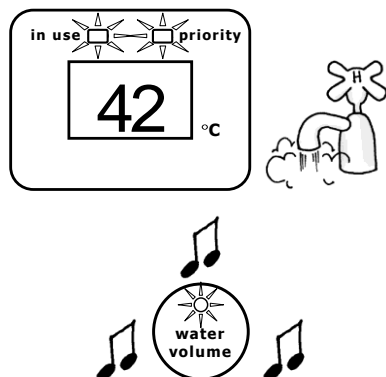

## 5. Turn off the alarm

- Press the water volume button to turn off the alarm.  
The water volume operating light goes out and 0 x10l is displayed momentarily on the controller.  
The temperature setting of the controller with priority is then displayed.

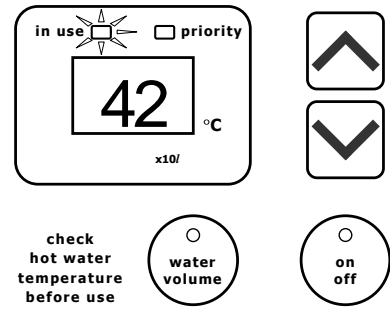

## 6. Close the hot tap

If it is a Bathroom controller which is in use and has priority, then it is advised to leave the controller on.

- Refer to the **warning** in the notes on page 16.  
If it is the Kitchen controller which is in use and has priority, then it is advised to turn the controller off.
- Refer to **Important** note for Bathroom controllers on page 16.

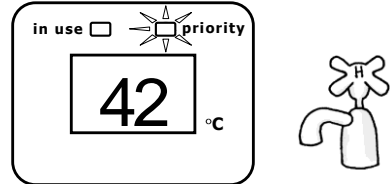

### Notes on the water volume function:

- The water volume can only be set by the Kitchen controller.
- The Kitchen controller does not require priority nor to be on in order to set the water volume function.
- The water volume function can be set whilst a hot tap is open.
- The water volume alarm will only sound from the Kitchen controller.
- The water volume alarm will still sound if the Kitchen controller has been silenced (refer to “**Silencing A Controller**” on page 11).
- The factory preset water volume is 180 litres.
- If a hot tap is not opened for one hour after the new water volume has been set, then the setting will be automatically cancelled. The water volume resets to the previously set water volume (or the factory preset water volume if no water volume has previously been set).
- To display the remaining water volume while water is being drawn, press the water volume button. After a few seconds, the display returns to the temperature setting.
- To turn off the water volume function before the alarm sounds, press the water volume button twice.
- The water volume is measured as the water flows through the water heater. Therefore if more than one hot tap is open, the alarm will respond to the total water volume drawn from all taps and the expected water volume from the first tap will be decreased.
- If the hot tap is closed before the set water volume flows through the water heater and the water volume button is left on, then the alarm will sound when the remaining water volume is consumed during a later operation. To prevent the alarm from sounding, press the water volume button twice to turn it off.

---

## TEMPERATURE CONTROL – DELUXE

---

### DELUXE CONTROLLER FUNCTIONS

If one or more Deluxe controllers are installed, at least one must be on or the bath fill function activated for the water heater to operate. If all Deluxe controllers and the bath fill function are off, the water heater will only deliver cold water.

**ON / OFF** button – The ON / OFF button must be pressed once to turn on the Deluxe controller. A Deluxe controller cannot be turned on if water is flowing from a hot tap.

To turn off a Deluxe controller, press the ON / OFF button once. A Deluxe controller can be turned off whilst water is flowing.

**ON / OFF** operating light – The light in the ON / OFF button will glow when the Deluxe controller is turned on.

The light will go out when the Deluxe controller is turned off.

**ACTIVE** light – The ACTIVE light will glow on a Deluxe controller when the controller is 'active', i.e. it has priority. The Bathroom Deluxe controller(s), if they are turned on, are 'active' and have priority over the Kitchen Deluxe controller.

ACTIVE or priority means that Deluxe controller has control of the water heater temperature setting. The water temperature setting can only be adjusted by a Deluxe controller that has priority and is displaying the ACTIVE light.

**operating** light – The operating light will glow on all Deluxe controllers, whether they are on or off, when hot water is flowing, regardless of which Deluxe controller has priority.

**temperature** display panel – The current temperature setting is displayed in °C on all Deluxe controllers (whether hot water is flowing or not), when any Deluxe controller is on. If all Deluxe controllers are off, the display remains blank.

**▲(up** button) – The up button increases the water temperature setting (refer to [“Temperature Adjustment – Deluxe Controllers”](#) on page 25).

**▼(down** button) – The down button decreases the water temperature setting (refer to [“Temperature Adjustment – Deluxe Controllers”](#) on page 25).

**assistance call** button – Pressing this button sounds an alert message on all Deluxe controllers, indicating that assistance is required in the room from which the assistance call button was activated.

**speaker** – The audio of the voice prompts and chimes is emitted from the speaker.

**BATH FILL** button – The BATH FILL button must be pressed once to turn on the Bath Fill mode.

When the Bath Fill mode is turned on, the last selected bath fill water volume in litres will be displayed in the bath fill water volume display panel and the last selected bath fill temperature in °C will be displayed in the 'temperature' display panel.

The bath fill water volume and temperature can be adjusted by using the BATH FILL VOLUME and BATH FILL TEMPERATURE buttons located behind the hinged panel on the lower half of the Deluxe controller (refer to [“Bath-Fill Mode”](#) on page 30).

To turn off the Bath Fill mode, press the BATH FILL button.

**BATH FILL** operating light – The light in the BATH FILL button will glow when the BATH FILL button is pressed and the Bath Fill mode is turned on.

The light in the button will flash when the selected bath fill function is complete but before the Bath Fill mode has been turned off.

The light will go out when the BATH FILL button is pressed and the Bath Fill mode is turned off.

**bath fill water volume** display panel – The selected bath fill water volume is displayed in litres on all Deluxe controllers.

The selected bath fill water volume is displayed whenever the Bath Fill mode is on (refer to “**Bath Fill Mode**” on page 30) or when the bath fill water volume is being adjusted and the Bath Fill mode is off.

If the bath fill water volume is being adjusted and the Bath Fill mode is off, then the bath fill water volume display panel goes blank three (3) seconds after a BATH FILL VOLUME button is last pressed.

At other times, if the Bath Fill mode is off, the bath fill water volume display panel remains blank.

**bath fill indicator light** – this light in the display panel will glow when the bath fill water volume is displayed.

**BATH FILL TEMPERATURE ▲ (up button)** – The up button increases the bath fill water temperature setting (refer to “**Temperature Adjustment – Deluxe Controllers**” on page 25 and to “**Bath Fill Mode**” on page 25).

**BATH FILL TEMPERATURE ▼ (down button)** – The down button decreases the bath fill water temperature setting (refer to “**Temperature Adjustment – Deluxe Controllers**” on page 25 and to “**Bath Fill Mode**” on page 25).

**BATH FILL VOLUME ▲ (up button)**– The up button increases the bath fill water volume setting in increments of 10 litres up to 500 litres. A further setting of 990 litres can be selected.

**BATH FILL VOLUME ▼ (down button)** – The down button decreases the bath fill water volume setting from 990 litres to 500 litres and in increments of 10 litres from 500 litres down to 10 litres.

**DELUXE CONTROLLER**

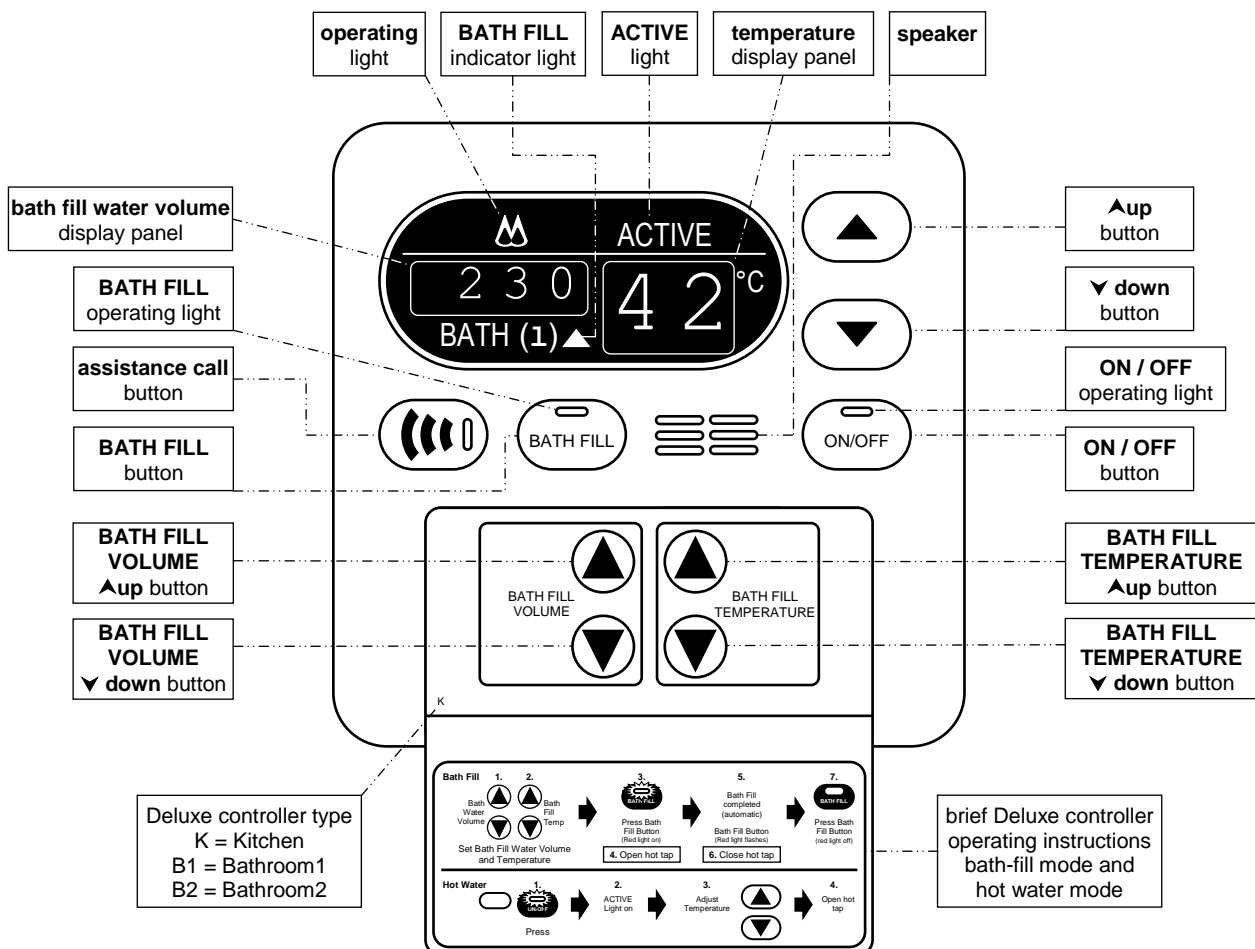

### VOICE PROMPT AND OPERATING TONE

The Deluxe controllers have a series of voice prompts and operating tones which sound during certain operations.

The voice prompts and operating tones sound from all Deluxe controllers, regardless of which Deluxe controller is being operated at the time.

#### Voice Prompt

The voice prompts are:

- When either the up (▲) button or BATH FILL TEMPERATURE ▲ (up button) is pressed  
*“hot water temperature has been increased”*
- When either the down (▼) button or BATH FILL TEMPERATURE ▼ (down button) is pressed  
*“hot water temperature has been decreased”*
- When the BATH FILL VOLUME ▲ (up button) is pressed  
*“Caution, bath fill water volume has been increased, bath may overflow”*
- When the BATH FILL VOLUME ▼ (down button) is pressed  
*“bath fill water volume has been decreased”*
- When the BATH FILL button is pressed to turn on the bath Fill mode  
*“please set bath water volume and bath temperature, then open the hot water tap”*
- When the set bath fill water volume has been delivered from the water heater during Bath Fill mode  
*“the bath is ready, please turn off the hot water tap and press the BATH FILL button to finish”*
- When the BATH FILL button is pressed to halt the bath fill function before it is complete  
*“bath filling has been stopped, please turn off the hot water tap and press the BATH FILL button to finish”*
- When the BATH FILL button is pressed to turn the Bath Fill mode off and the hot tap has not been turned off  
*“please ensure the bath hot water tap is turned off”*
- When the Deluxe controllers have been turned off during the bath fill function  
*“bath filling has been stopped”*
- When the assistance call button is pressed  
*“assistance required, assistance required”*

#### Operating Tone

The operating chime will sound when the temperature adjustment up (▲) button or down (▼) button is pressed and the voice prompt is not speaking.

The operating beep will sound for each change in temperature increment when a BATH FILL TEMPERATURE adjustment button is pressed or scrolled, whether the voice prompt is speaking or not.

The operating beep will sound for each change in volume increment when a BATH FILL VOLUME adjustment button is pressed or scrolled and the voice prompt is not speaking.

### Adjusting the Volume of the Voice Prompt and Operating Tone

The volume of the voice prompt and the operating tone can be adjusted to a level comfortable for you. The volume of the voice prompt and the operating tone can be adjusted independently of each other. The volume levels on a Deluxe controller are adjusted independently of another Deluxe controller.

The voice prompt and / or operating tone can also be turned off on an individual or all Deluxe controllers so they do not sound at all.

The factory default volume setting of both the voice prompt and operating tone is medium [med]. If there is an interruption to the water heater power supply, the volume of both the voice prompt and operating tone returns to the default setting.

When adjusting the volume levels, the operating tone volume level is indicated by a chime, followed by the voice prompt volume level which is indicated by two beeps. If during the volume setting procedure only the chime is audible, this indicates the voice prompt is off. If during the volume setting procedure only the two beeps is audible, this indicates the operating tone is off.

To adjust or turn off the volume for the voice prompt and operating tone:

- Turn off all Deluxe controllers.
- Press and hold the up (▲) button, then within four (4) seconds press the ON / OFF button.

Each press of the ON / OFF button will change the voice prompt and operating tone in the following sequence:

- operating tone [MAX], voice prompt [OFF]
- operating tone [MIN], voice prompt [MIN]
- operating tone [MIN], voice prompt [OFF]
- operating tone [OFF], voice prompt [OFF]
- operating tone [MAX], voice prompt [MAX]
- operating tone [MED], voice prompt [OFF]
- operating tone [MED], voice prompt [MED]

This order then repeats.

**Note:** If the ON / OFF button is not pressed within four (4) seconds of the up (▲) button being pressed, “CL” will start flashing on the temperature display panel. If this occurs, release the up (▲) button and recommence the procedure.

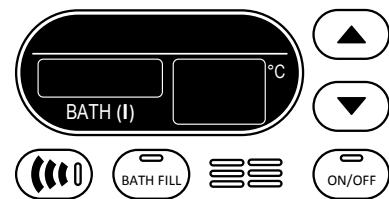

### ASSISTANCE CALL FUNCTION

A Deluxe controller has an assistance call button. Should assistance be required, such as when in the bathroom, a voice prompt will sound on all Deluxe controllers to notify others that assistance is required.

The Deluxe controller does not have to be on for the assistance call function to be activated and the function can be activated during any operation.

#### To Call for Assistance

To operate the assistance call function:

1. **Press the green assistance call button.**

The voice prompt will sound on all Deluxe controllers, “assistance required, assistance required”

The red light in the assistance call button will glow on all Deluxe controllers for the duration of the voice prompt.

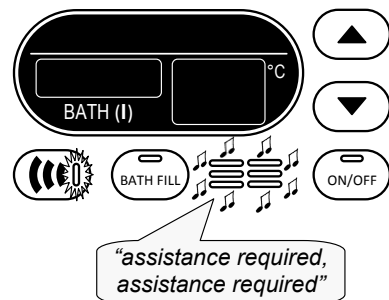

**TEMPERATURE SETTINGS – DELUXE CONTROLLERS**

The temperature settings of each type of Deluxe controller are:

- Bathroom1 & 2 Deluxe      37°C to 48°C\* (in 1°C increments), 50°C
- Kitchen Deluxe              37°C to 48°C\* (in 1°C increments), 50°C\*, 55°C  
(Limited to 48°C when set in bathfill mode.)

Temperature settings

37	38	39	40	41	42	43	44	45	46	47	48	50	55
warm			average hot shower					hot			very hot		

The installation of a Bathroom Deluxe controller(s) only (i.e. no Kitchen Deluxe controller) limits the temperature setting of the water heater to a maximum of:

- 874 series                      50°C
- 872 series                      50°C

regardless of the preset outlet temperature setting of the water heater.

The installation of a Kitchen Deluxe controller will allow a maximum temperature setting of:

- 874 series                      55°C
- 872 series                      55°C

regardless of the preset outlet temperature setting of the water heater.

If deluxe or standard controllers are not installed, the water heater defaults to the factory preset outlet temperature setting in the first instance. This may be changed by the installer up to:

- 874 series                      75°C
- 872 series                      82°C

Refer to [“How Hot Should The Water Be?”](#) on page 5.

To enable the delivery of water temperatures above 55°C to the kitchen, laundry or other non-ablution area, no controllers can be connected to either the 874 or 872 series. A separate untempered pipe work must be installed from the water heater to the hot water outlets in these locations and the water heater temperature setting can be increased up to:

- 874 series                      75°C
- 872 series                      82°C



**TEMPERATURE ADJUSTMENT – DELUXE CONTROLLERS**

- A controller must be on with the ACTIVE indicator displayed to be able to adjust the temperature setting.
- The temperature adjustment is made by pressing the up (▲) button or down (▼) button.
- The minimum temperature setting for each type of controller is 37°C.
- The maximum temperature setting for the controllers are:

	Kitchen	Bathroom
874 series	55°C	50°C
872 series	55°C	50°C

- Each press of the up (▲) button will increase the temperature setting by one increment.
- Pressing and holding the up (▲) button will scroll the temperature setting up to a maximum 43°C if there is hot water flowing or 45°C if there is no hot water flowing.
- From the 45°C setting, the up (▲) button must be pressed once for each increase in temperature increment.
- The temperature setting cannot be increased above 43°C whilst hot water is flowing.
- Each press of the down (▼) button will decrease the temperature setting by one temperature increment.
- Pressing and holding the down (▼) button will scroll down the temperature setting.
- The temperature setting can be decreased from any temperature setting whether the hot water is flowing or not.

**Note:** A Deluxe controller sounds a double beep at the 42°C temperature setting, if the voice prompt is not speaking, when either the up (▲) button or down (▼) button has been pressed. The double beep does not sound at the 42°C temperature setting when the BATH FILL TEMPERATURE ▲ (up button) or BATH FILL TEMPERATURE ▼(down button) is pressed.

### KITCHEN CONTROLLER – DELUXE

The Kitchen Deluxe controller allows the user to select the temperature setting for the hot water to be used in the kitchen and laundry. It has a minimum temperature setting of 37°C and a maximum temperature setting of:

- 874 series                      55°C
- 872 series                      55°C

The Kitchen Deluxe controller does not have priority (ACTIVE light is off) if a Bathroom Deluxe controller is on.

#### Notes on the Kitchen Deluxe controller:

- The Deluxe controller cannot be turned on whilst a hot tap is open.
- The Kitchen Deluxe controller must be on and have priority (ACTIVE light glows) in order to adjust the temperature setting on the Kitchen Deluxe controller.
- The Bathroom Deluxe controller(s) can be turned off from the Kitchen Deluxe controller.

Press and hold the ON / OFF button on the Kitchen Deluxe controller for three seconds. This turns off all the Deluxe controllers, including the bath fill function if it is on, the displays go blank and the lights go out. If hot water is flowing from a hot tap, it will go cold.

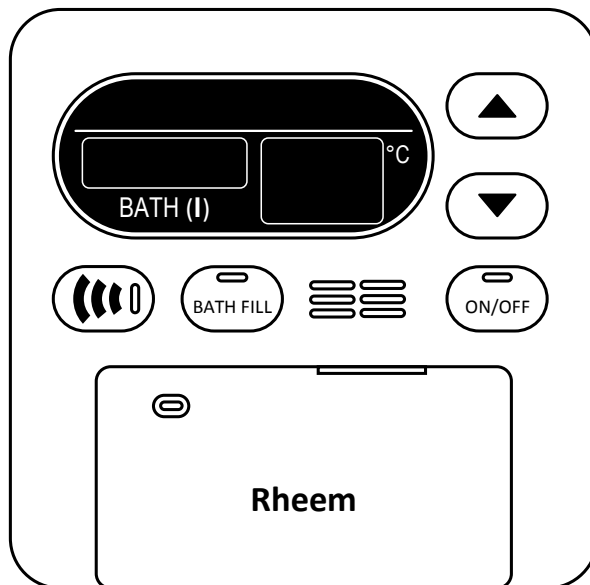

**Kitchen Deluxe Controller**

To operate the Kitchen Deluxe controller:

**1. Turn off the Bathroom Deluxe controller(s)**

- If a temperature setting is displayed and the ACTIVE light is not glowing, it is necessary to turn off the Bathroom Deluxe controller(s) to gain priority.
- Refer to the notes on the [Kitchen Deluxe controller](#) on page 26.

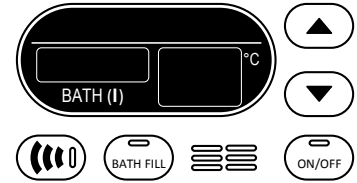

**2. Turn on the Kitchen Deluxe controller**

- Press the ON / OFF button.  
The light in the ON / OFF button and the ACTIVE light will both glow.  
The previous Kitchen Deluxe controller temperature setting will be displayed on the temperature display panel.

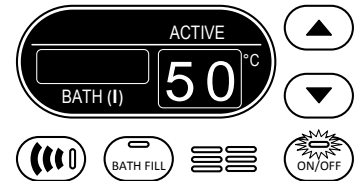

**3. Select the temperature setting**

- Press the up (▲) button or down (▼) button.  
When the down (▼) button is pressed, the voice prompt will sound;  
*“hot water temperature has been increased”*  
When the down (▼) button is pressed, the voice prompt will sound;  
*“hot water temperature has been decreased”*
- Refer to [“Temperature Adjustment – Deluxe Controllers”](#) on page 25.  
The selected temperature setting will be displayed on all Deluxe controllers.

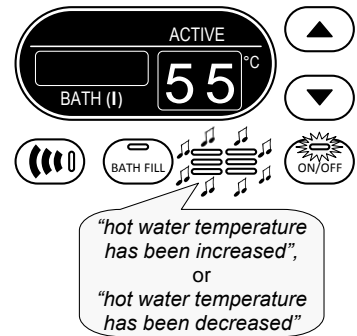

**4. Open the hot tap.**

The operating light will glow on all Deluxe controllers.

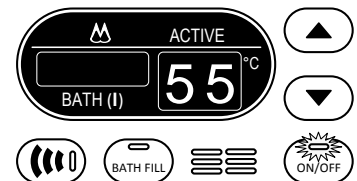

**5. Close the hot tap.**

The operating light will go out on all Deluxe controllers, if no other hot tap is open.



**6. Turn off the Kitchen Deluxe controller**

- Press the ON / OFF button.  
The ACTIVE light and the ON / OFF light will go out and the temperature display panel will go blank.

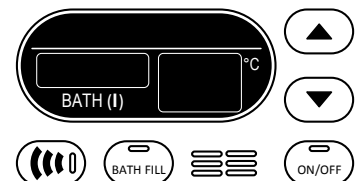

**Important:** Turn off the Kitchen Deluxe controller after hot water usage is finished in the kitchen and / or laundry. Refer to **Important** note for Bathroom Deluxe controllers on page 28.

**BATHROOM CONTROLLERS – DELUXE**

The Bathroom Deluxe controller(s) allows the user to select the temperature setting for the hot water to be used in the bathroom. They have a minimum temperature setting of 37°C and a maximum temperature setting of:

- 874 series                                50°C
- 872 series                                50°C

The Bathroom Deluxe controllers operate in tandem. Whenever an operation is selected on one Bathroom Deluxe controller, it is also set on the other Bathroom Deluxe controller. The Bathroom Deluxe controllers automatically have priority (ACTIVE light glows) if they are on.

**Important:** It is important to turn on the Bathroom Deluxe controller before opening a hot tap in the bathroom (priority is gained automatically and the ACTIVE light glows). If the Bathroom Deluxe controller is not on and the Kitchen Deluxe controller is on (will have priority and ACTIVE light glows), then it is possible to receive water at a temperature higher than expected from a hot tap in the bathroom. This temperature could be up to:

- 874 & 872 series                        55°C if a temperature limiting device is installed in the hot pipe to the bathroom or up to 55°C if a temperature limiting device is not installed.

**Notes on the Bathroom Deluxe controllers:**

- The Deluxe controller cannot be turned on whilst a hot tap is open.
- When a Bathroom Deluxe controller is turned on, it gains priority (ACTIVE light glows) from the Kitchen Deluxe controller.
- The Bathroom Deluxe controller must be on in order to adjust the temperature setting on the Bathroom Deluxe controller.
- The Kitchen Deluxe controller can be turned off from a Bathroom Deluxe controller.

Press and hold the ON / OFF button on the Bathroom Deluxe controller for three seconds. This turns off all the Deluxe controllers, including the bath fill function if it is on, the displays go blank and the lights go out. If hot water is flowing from a hot tap, it will go cold.

- **⚠ Warning:** It is advised to leave the Bathroom Deluxe controller on after hot water usage is finished in the bathroom. **Turning off a Bathroom Deluxe controller in one bathroom will also turn off the Bathroom Deluxe controller in the other bathroom.** The Kitchen Deluxe controller will gain priority (ACTIVE light glows) if it is on and the temperature setting can be up to:

- 874 series                                55°C
- 872 series                                55°C

If a hot tap is open in another bathroom, the water will be delivered at up to 55°C for an 874 series model if a temperature limiting device is installed in the hot pipe to the bathroom, or up to 55°C if a temperature limiting device is not installed.

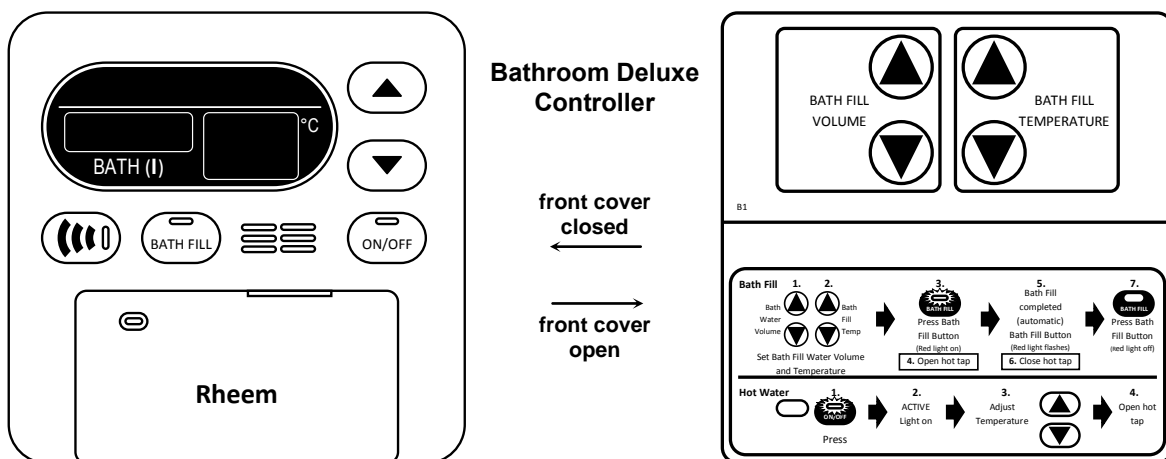

To operate a Bathroom Deluxe controller:

**1. Turn off the Kitchen Deluxe controller**

- If a temperature setting is displayed and the ACTIVE and ON / OFF operating lights are not glowing, it is advised to turn off the Kitchen Deluxe controller.

Refer to the notes on the [Bathroom Deluxe controllers](#) on page 28.

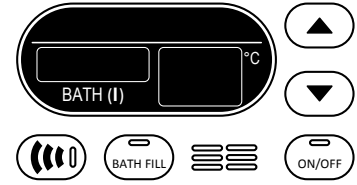

**2. Turn on the Bathroom Deluxe controller**

- Press the ON / OFF button.

The light in the ON / OFF button and the ACTIVE light will both glow.

The previous temperature setting of the Bathroom Deluxe controller will be displayed on the temperature display panel.

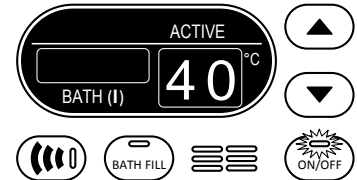

**3. Select the temperature setting**

- Press the up (▲) button or down (▼) button.

When the up (▲) button is pressed, the voice prompt will sound;

*“hot water temperature has been increased”*

When the down (▼) button is pressed, the voice prompt will sound;

*“hot water temperature has been decreased”*

- Refer to [“Temperature Adjustment – Deluxe Controllers”](#) on page 25.

The selected temperature setting will be displayed on all Deluxe controllers.

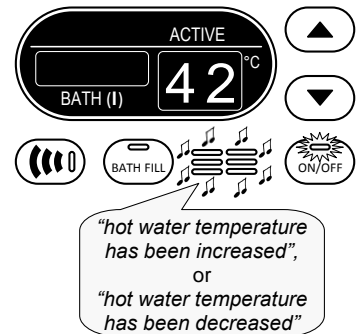

**4. Open the hot tap**

The operating light will glow on all Deluxe controllers.

**5. Close the hot tap**

The operating light will go out on all Deluxe controllers, if no other hot tap is open.

It is advised not to turn off the Bathroom Deluxe controller(s).

- Refer to the [warning](#) in the notes on page 28.

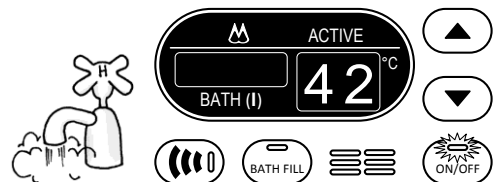

**BATH FILL MODE**

The Bath Fill mode is designed to allow the water heater to deliver a selected volume of water at a selected temperature. The Bath Fill mode commences when the BATH FILL button is on and a hot tap is opened. When the set volume has been delivered, the water flow from the water heater ceases and heating stops. It is also useful for controlling the water volume used by a shower or other application.

**Note:** The bath level should be monitored periodically while this function is in use to avoid the possibility of the bath overflowing. The Bath Fill mode should be used with caution until you are familiar with its operation.

**Warning:** Baths should not be left unattended whenever young children are present. After using the bath fill function, check the water temperature before entering a bath, to ensure it is suitable and will not cause scald injury.

The Bath Fill mode can be set and turned off at any of the Deluxe controllers. Refer to the [notes](#) on page 36.

**Bath Fill Mode – Brief Guide**

This guide provides a brief instruction on the operating sequence of the bath fill function. It is recommended to read the explanatory notes and become familiar with each step in the bath fill function. Refer to [“Bath Fill Mode – Explanatory Notes”](#) on page 32.

To operate the Bath Fill Mode:

**1. Turn off all Deluxe controllers**

- It is advised to turn off all Deluxe controller(s) before activating the Bath Fill mode.

Refer to the notes on the [Bathroom Deluxe controllers](#) on page 28.

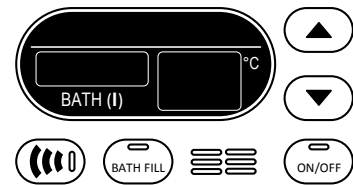

**2. Pull down the front panel on the Deluxe controller.**

The BATH FILL VOLUME and BATH FILL TEMPERATURE up (▲) and down (▼) buttons will be exposed.

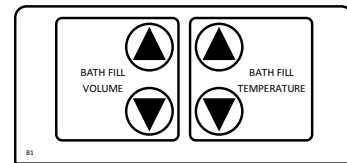

**3. Set the Bath Fill temperature**

- Press the BATH FILL TEMPERATURE ▲ (up button) or the BATH FILL TEMPERATURE ▼ (down button) to select the desired bath fill temperature.
- Refer to [“Temperature Adjustment – Deluxe Controllers”](#) on page 25.

The selected temperature setting will be displayed on all Deluxe controllers.

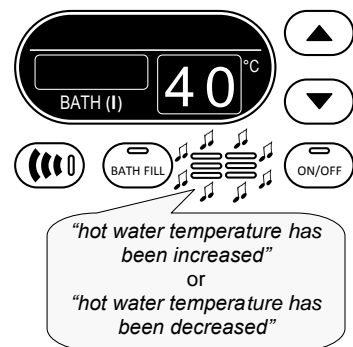

**4. Set the bath fill water volume**

- Press the BATH FILL VOLUME ▲ (up button) or the BATH FILL VOLUME ▼ (down button) to select the desired bath fill water volume. Each press will change the water volume setting by 10 litres.

Pressing the BATH FILL VOLUME ▲ (up button) or BATH FILL VOLUME ▼ (down button) continuously will scroll the water volume setting.

A maximum volume of 990 litres and a minimum volume of 10 litres can be set. The volume changes in 10 litre increments.

The selected bath fill water volume will be displayed and the bath fill indicator light will glow on all Deluxe controllers.



5. Close the front panel on the Deluxe controller.

6. Turn on the Bath Fill mode

- Press the BATH FILL button.
  - On all Deluxe controllers:
    - The BATH FILL operating light will glow.
    - The bath fill temperature setting will appear on the temperature display panel.
    - The bath fill water volume will appear on the bath fill water volume display panel.
    - The bath fill indicator light will glow.

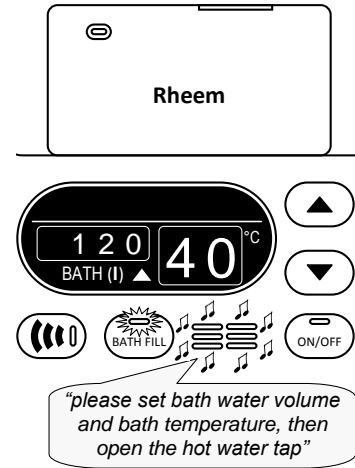

7. Open the hot tap.

The operating light will glow on all Deluxe controllers.

Measurement of the water flow at the water heater will commence when the hot tap is opened.

When the set volume of water has passed through the water heater:

- Water flow from the hot tap will cease.
- The operating light will go out.
- The bath fill water volume display panel will show 0 litres.
- The temperature display will go blank.
- The BATH FILL operating light will commence to flash
- The voice prompt will sound;
  - “the bath is ready, please turn off the hot water tap and press the BATH FILL button to finish”*

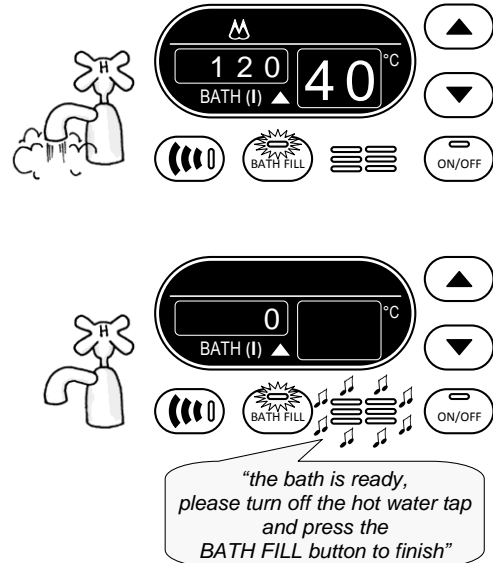

8. Close the hot tap.

9. Turn off the Bath Fill mode

- Press the BATH FILL button.
  - The BATH FILL operating light and bath fill indicator light will go out.
  - The BATH FILL operating light and bath fill indicator light will go out.
  - The bath fill water volume display will go blank.
  - Note:** If the hot tap has not been turned off, the voice prompt will sound;
    - “please ensure the bath hot water tap is turned off”*

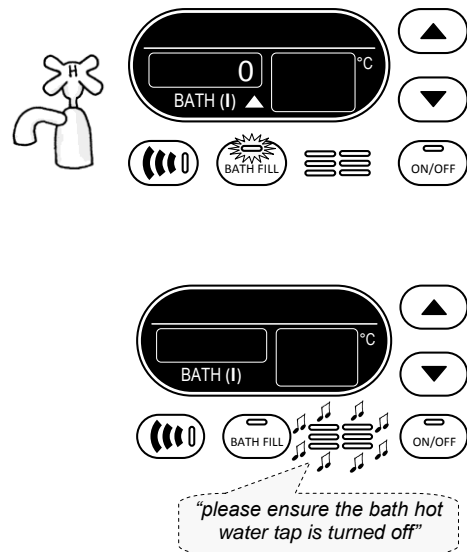

**Bath Fill Mode – Explanatory Notes**

To operate the Bath Fill mode:

**1. Turn off all Deluxe controllers**

- It is advised to turn off all Deluxe controller(s) before activating the Bath Fill mode.

Refer to the notes on the [Bathroom Deluxe controllers](#) on page 28.

The Deluxe controllers do not need to be on to set the bath fill temperature and bath fill water volume and to turn on the Bath Fill mode.

**2. Pull down the front panel on the Deluxe controller.**

The BATH FILL VOLUME and BATH FILL TEMPERATURE up (▲) and down (▼) buttons will be exposed.

**3. Set the bath fill temperature**

- Press the BATH FILL TEMPERATURE ▲(up button) or the BATH FILL TEMPERATURE ▼(down button).

The first press of either the BATH FILL TEMPERATURE (up button) or the BATH FILL TEMPERATURE (down button) will bring up the last selected bath fill temperature setting.

While the bath fill temperature is displayed, each subsequent press of the BATH FILL TEMPERATURE (up button) or BATH FILL TEMPERATURE (down button) will change the temperature setting.

Refer to “[Temperature Adjustment – Deluxe Controllers](#)” on page 25.

When the BATH FILL TEMPERATURE ▲(up button) is pressed and the temperature setting is increased, the voice prompt will sound;

*“hot water temperature has been increased”*

When the BATH FILL TEMPERATURE (down button) is pressed and the temperature setting is decreased, the voice prompt will sound;

*“hot water temperature has been decreased”*

The selected temperature setting will be displayed in the temperature display panel and will be displayed on all Deluxe controllers.

The temperature display panel will go blank 3 seconds after the last press of either of the bath fill temperature adjustment buttons.

The bath fill temperature setting will be remembered when the BATH FILL button is pressed “on”.

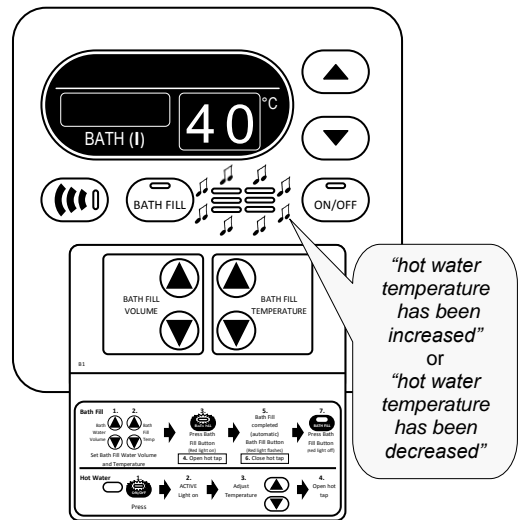
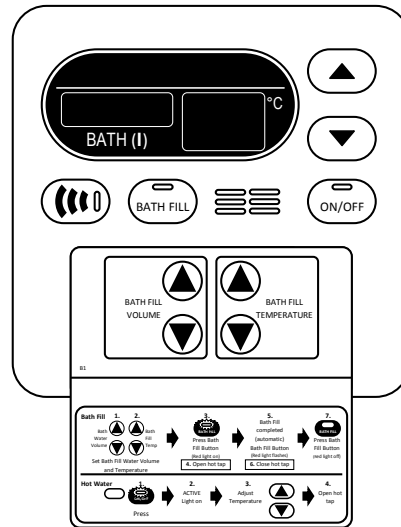



**4. Set the bath fill water volume**

- Press the BATH FILL VOLUME (up button) or the BATH FILL VOLUME (down button).

The first press of either the BATH FILL VOLUME ▲(up button) or the BATH FILL VOLUME ▼(down button) will display the last selected bath fill water volume setting in the bath fill water volume display panel and the bath fill indicator light will glow.

While the bath fill water volume is displayed, each subsequent press of the BATH FILL VOLUME ▲(up button) or BATH FILL VOLUME ▼(down button) will change the water volume setting by 10 litres.

When the BATH FILL VOLUME ▲(up button) is pressed and the water volume setting is increased, the voice prompt will sound;

*“caution, bath fill water volume has been increased, bath may overflow”*

When the BATH FILL VOLUME ▼(down button) is pressed and the water volume setting is decreased, the voice prompt will sound;

*“bath fill water volume has been decreased”*

Pressing the BATH FILL VOLUME ▲(up button) or BATH FILL VOLUME ▼ (down button) continuously will scroll the water volume setting.

A maximum volume of 990 litres and a minimum volume of 10 litres can be set. The maximum volume of 990 litres is achieved in 10 litre increments up to 500 litres, then 990 litres is the next setting.

The selected bath fill water volume will be displayed and the bath fill indicator light will glow on all Deluxe controllers.

The bath fill water volume display panel will go blank and the bath fill indicator light will go out 3 seconds after the last press of either of the volume adjustment buttons.

The set volume will be remembered when the BATH FILL button is next pressed “on”.

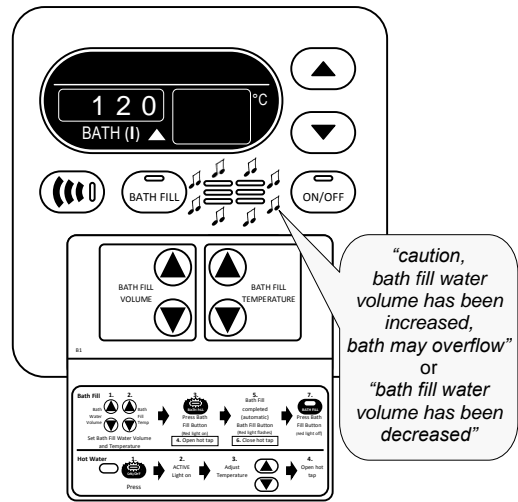

**5. Close the front panel on the Deluxe controller.**

**6. Turn on the Bath Fill mode**

- Press the BATH FILL button.

On all Deluxe controllers:

- The BATH FILL operating light will glow.
- The bath fill temperature setting will appear on the temperature display panel.
- The bath fill water volume will appear on the bath fill water volume display panel.
- The bath fill indicator light will glow.
- The voice prompt will sound;

*“please set bath water volume and bath temperature, then open the hot water tap”*

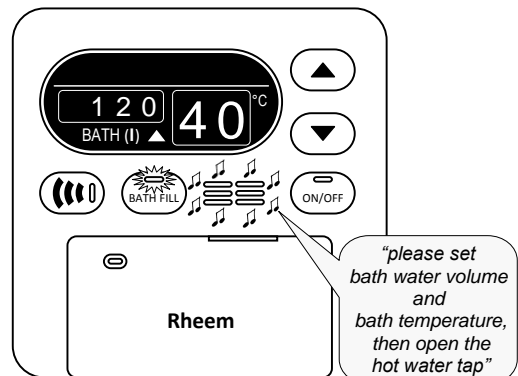
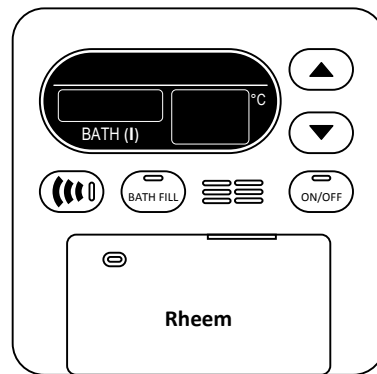

**7. Open the hot tap.**

The operating light will glow on all Deluxe controllers.

Measurement of the water flow at the water heater will commence when the hot tap is opened.

**Notes:**

- If a second hot tap is opened when the Bath Fill mode is turned on, the set bath fill water volume expected from the first hot tap will be reduced by the volume which flows through the second hot tap.
- The bath fill temperature setting and bath fill water volume setting can also be adjusted whilst a hot tap is open and the Bath Fill mode is operating.

When the set volume of water has passed through the water heater:

- Water flow from the hot tap will cease.
- The operating light will go out.
- The bath fill water volume display panel will show 0 litres.
- The temperature display will go blank.
- The BATH FILL operating light will commence to flash
- The voice prompt will sound;  
*“the bath is ready, please turn off the hot water tap and press the BATH FILL button to finish”*

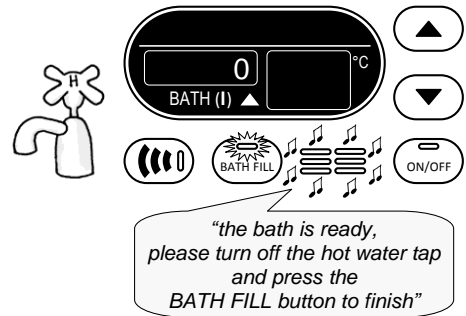
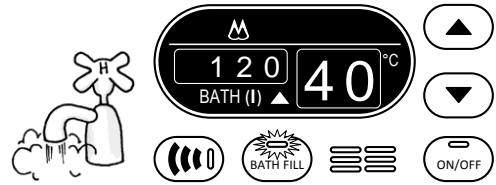

**8. Close the hot tap.**

**9. Turn off the Bath Fill mode**

- Press the BATH FILL button.  
 The BATH FILL operating light and bath fill indicator light will go out.  
 The bath fill water volume display will go blank.  
**Note:** If the hot tap has not been turned off, the voice prompt will sound;  
*“please ensure the bath hot water tap is turned off”*

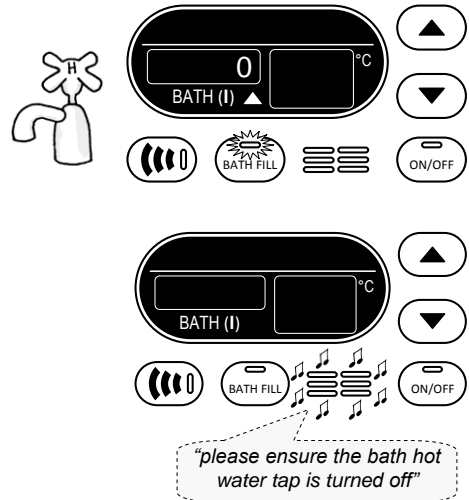

**Turning Off Bath Fill Mode During Its Operation**

The bath fill operation can be interrupted by pressing the BATH FILL button before completion of the bath fill operation.

If it is necessary to turn off the Bath Fill mode before the operation is complete, during **Step 7**:

- Press the BATH FILL button

At this first press of the BATH FILL button

- Water flow from the hot tap will cease
- The operating light will go out
- The bath fill water volume display panel will show 0 litres.
- The temperature display will go blank
- The bath fill operating light will flash
- The voice prompt will sound

*“bath filling has been stopped, please turn off the hot water tap and press the BATH FILL button to finish”*

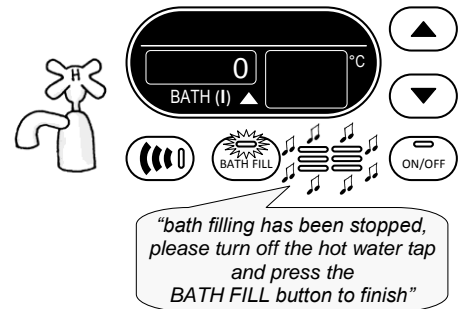

- Close the hot tap

- Press the BATH FILL button again

At this second press of the BATH FILL button

- The bath fill operating light and bath fill indicator light will go out
- The bath fill water volume display will go blank
- **Note:** If the hot tap has not been turned off, the voice prompt will sound

*“please ensure the bath hot water tap is turned off”*

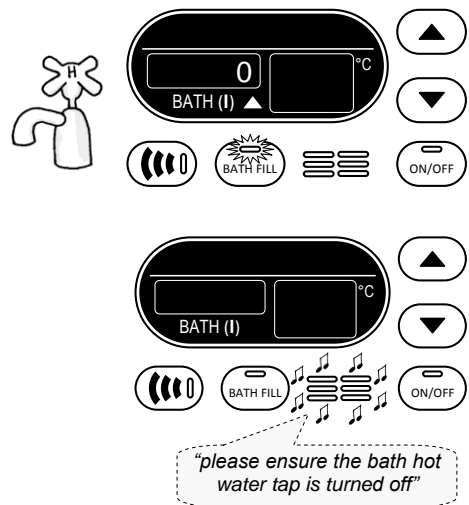

**Notes on the Bath Fill mode:**

- The Bath Fill mode can be set and turned on at any of the Deluxe controllers.
- The Deluxe controllers do not require to have priority (ACTIVE light glowing) or be on in order to set the bath fill water volume or bath fill temperature or to turn the BATH FILL button on.
- The BATH FILL button cannot be turned on whilst a hot tap is open.
- The bath fill water volume and the bath fill temperature settings can be adjusted whilst a hot tap is open.
- If a hot tap is not opened for six hours after the new bath fill water volume and bath fill temperature has been set, whilst the BATH FILL button is on, the settings will be automatically cancelled and will reset to the previous settings or to the factory default settings if no previous settings have been set.
- The factory default bath fill water volume setting is 180 litres.
- The factory default bath fill temperature setting is 40°C.
- The Bath Fill mode will automatically have priority when the BATH FILL button is pressed and the Bath Fill mode is turned on. If the ACTIVE light is glowing on a Deluxe controller, it will go out. The ACTIVE light on a Deluxe controller will not glow whenever the BATH Fill operating light is on.
- Whilst water is flowing from a hot tap during the bath fill operation (BATH FILL operating light is on), a Deluxe controller cannot be turned on or off:
  - if it is on, pressing the ON / OFF button will not turn it off
  - if it is off, pressing the ON / OFF button will not turn it on.
- Whilst there is no water flowing from a hot tap and the BATH FILL operating light is on, a Deluxe controller can be turned on (ON / OFF light glows), but it will not gain priority (ACTIVE light will not glow).
- Pressing the up (▲) button or down (▼) button above the ON / OFF button during the bath fill operation (BATH FILL operating light is on) will not adjust the temperature setting.

**Important**

- Ensure all hot taps are turned off after a bath fill operation is complete and before pressing the BATH FILL button “OFF”. Otherwise;
  - Water will flow from the hot tap when the BATH FILL button is pressed “OFF”.  
The water will be cold if all Deluxe controllers are off, or hot if a Deluxe controller is ACTIVE.
  - The voice prompt will also sound;  
*“please ensure the bath hot water tap is turned off”.*

### Opening a Second Hot Water Tap During Bath Fill Operation

- The bath fill water volume is measured as the water flows through the water heater. If more than one hot tap is open, the Bath Fill mode will measure the total water volume drawn from all taps and the expected water volume from the first tap will be decreased.
  - If the hot water supply should cease unexpectedly, check to see if the BATH FILL operating light is flashing
  - If the BATH FILL operating light is flashing, this indicates the set bath fill water volume has been delivered and the bath fill operation is complete
  - If further hot water is required for the application:
    - Turn off the hot tap
    - Press the bath fill button to turn off the Bath Fill mode
    - Recommence the Bath Fill procedure from Step 3, ensuring the water volume is adjusted to the volume required to complete the application.

### Early Completion of Bath Fill Operation

- If the hot tap is closed before the set water volume flows through the water heater and the Bath Fill button is left on, the Bath Fill mode remains active for six hours.
  - If during this time a hot tap is turned on, the bath fill operation continues until the remaining bath fill water volume is consumed, then
 

The water flow will cease and the voice prompt will sound;

*“the bath is ready, please turn off the hot water tap and press the BATH FILL button to finish”*

    - Close the hot tap
    - Press the BATH FILL button
  - To prevent the bath fill operation completing and interrupting the hot water supply, whilst the hot tap is off, then
    - press the BATH FILL button twice to turn it off

The first press of the BATH FILL button causes the bath fill operating light to flash and the voice prompt will sound

*“bath filling has been stopped, please turn off the hot water tap and press the BATH FILL button to finish”*

The second press of the BATH FILL button causes the bath fill operating light to go off.

### Interrupting Bath Fill Operation

- The bath fill operation can be interrupted by:
  - Pressing the BATH FILL button before completion of the bath fill operation
 

Refer to [“Turning Off Bath Fill Mode During Its Operation”](#) on page 35, or by
  - Pressing and holding the ON / OFF button on any Deluxe controller for three seconds.
 

This turns off all the Deluxe controllers, including the bath fill function. The displays go blank and the lights go out.

A voice prompt will sound;

*“bath filling has been stopped”*

Hot water flowing from a hot tap will go cold.

    - Turn off the hot tap.

**Operation of the Bath Fill mode whilst a Deluxe Controller is ACTIVE**

It is recommended the Bath Fill mode be set and operated with the Deluxe controllers turned off (refer to [Step 1](#) on page 32).

However, if a Deluxe controller is ACTIVE during the setting and operation of the Bath Fill mode, then the following additional events occur:

**During Step 3**, when the bath fill temperature is being set

- The temperature setting of the ACTIVE Deluxe controller will display in the temperature display panel three seconds after the BATH FILL TEMPERATURE button is last pressed.

When the Deluxe controller temperature setting is higher than the bath fill temperature setting, the voice prompt will sound;

*“hot water temperature has been increased”*

When the Deluxe controller temperature setting is lower than the bath fill temperature setting, the voice prompt will sound;

*“hot water temperature has been decreased”*

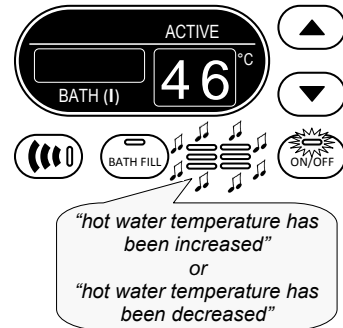

**During Step 6**, when the BATH FILL button is pressed to turn the Bath Fill mode on

The Bath Fill mode has priority when operating. When the BATH FILL button is pressed, the Bath Fill mode will gain priority and over-ride the settings of all Deluxe controllers if they are on.

- The ACTIVE light will go out if it is on.
- The bath fill temperature setting will replace the temperature setting in the temperature display panel.

When the bath fill temperature setting is lower than the Deluxe controller temperature setting, the voice prompt will sound;

*“hot water temperature has been decreased”*

When the bath fill temperature setting is higher than the Deluxe controller temperature setting, the voice prompt will sound;

*“hot water temperature has been increased”*

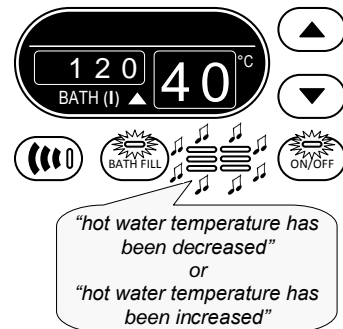

**During Step 9**, when the BATH FILL button is pressed to turn the Bath Fill mode off

- The ACTIVE light will glow on the Deluxe controller which has priority.
- The temperature setting of the ACTIVE Deluxe controller will display in the temperature display panel.



**Notes**

- If it is a Bathroom Deluxe controller which is in use and it is on, i.e. it has priority and the ACTIVE light is glowing, then it is advised to leave the controller on.  
Refer to the [warning](#) in the notes on page 28.
- If it is the Kitchen Deluxe controller which is in use and it is on, i.e. it has priority and the ACTIVE light is glowing, then it is advised to turn the controller off.  
Refer to [Important](#) note for Bathroom controllers on page 28.

---

## SAVE A SERVICE CALL

---

Check the items below before making a service call. You will be charged for attending to any condition or fault, which is not related to manufacture or failure of a part (refer to “[Warranty](#)” on page 75).

### NO DISPLAY ON THE CONTROLLER

- Is the controller turned on?  
Press the on / off button (refer to “[Temperature Control](#)” on pages 9 to 38).
- Is the water heater plugged in and the power outlet switched on?
- Is power available in the house?  
Try using another electrical appliance.

### COLD WATER FROM THE HOT OUTLET

- Is the controller turned on?  
Press the on / off button (refer to “[Temperature Control](#)” on pages 9 to 38).
- Close the hot outlets, wait 10 seconds and open the hot tap again.
- Is the hot outlets open enough?  
The burners will not light if the flow rate is less than 3.0 L / min.
- Is the water heater plugged in and the power outlet switched on?
- Is power available in the house?  
Try using another electrical appliance.
- Is the isolation valve in the gas line open?
- Is there a gas supply to the rest of the house?  
Try lighting another gas appliance.
- Has the gas line been purged of air after installation?  
Refer to your plumber.

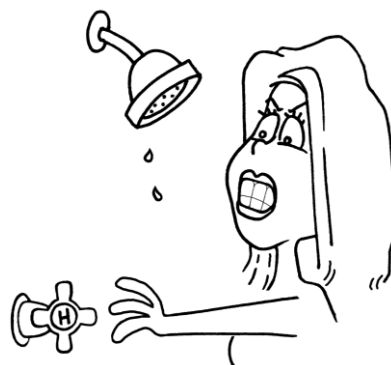

### WATER IS TOO HOT OR NOT HOT ENOUGH

- Does the controller you are using have priority? (refer to “[Temperature Control](#)” on pages 9 to 38)

### NO WATER FROM THE HOT OUTLETS

No flow of water from the hot outlets may indicate a restriction in or failure of the cold water supply to the water heater. Check for water flow at other taps and that the cold water isolation valve ([refer to page 54](#)) is fully open.

### WATER FLOW FLUCTUATES

More than two or three outlets in use at the same time may cause a decrease in the hot water flow from the taps. This can also be evident if the water heater has been installed as a gas booster water heater to a solar preheat water heater and the solar preheat water is at a low temperature.

- Are there more than two or three taps open, or are appliances such as a dishwasher or washing machine, in use at the same time?  
Ensure only two or three taps or appliances are on at the one time.
- Check the flow of the water from one tap, eg, the shower.  
The shower should be adjusted so the hot tap is fully open.

### **GAS BOOSTER OPERATING TOO FREQUENTLY**

If the water heater is installed as a gas booster water heater to a solar preheat water heater, you may find that the water heater operates more frequently than expected. This will occur when the solar preheat water temperature is lower than 58°C (864 series) or 2°C lower than the preset outlet temperature (862 series) (refer to page 4 **Gas Boosting For A Solar Water Heater**

) which may be experienced during periods of low solar energy gain or if there has been heavy hot water usage. Factors to consider are:

- **Hot tap not used recently**

If a hot tap has not been used for a while, the water in the pipe work between the solar water heater and the gas booster water heater may have cooled down. The water heater will sense the cooler water and this will cause the burners on the water heater to ignite and boost the water temperature when a hot tap is first turned on. The burners will extinguish when solar preheated water of 58°C or higher from the solar storage tank reaches the water heater (refer also to [“Fan Continues to Run after Water Heater Operation Stops”](#) on page 40).

- **Insufficient sunlight**

Insufficient sunlight due to cloudy weather during summer months or low solar energy contribution in winter months may mean the gas booster operates more often.

- **Collectors shaded**

If trees or other objects shade the solar collectors or if the glass is dirty, the effectiveness of the solar collectors will be greatly reduced. Have the trees trimmed or the solar collectors relocated if the obstruction is permanent or clean the collector glass.

Ensure the glass on your solar collectors is free of dust, salt spray or any other matter, which may reduce the effectiveness of the solar collectors. If the collector glass becomes dirty, hose down or if the solar collectors are accessible, wash the collector glass with water and a soft brush when the solar collectors are cool.

- **Collector area is too small**

For most installations, the number of solar collectors recommended in Rheem literature has been proven to provide the required solar energy to meet the average family needs. However, in some circumstances, it may be necessary to install an additional solar collector.

- **Are you using more hot water than you think?**

Is one outlet (especially the shower) using more hot water than you think?

Very often it is not realised the amount of hot water used, particularly when showering. Carefully review the family's hot water usage. As you have installed an energy saving appliance, energy saving should also be practised in the home. Adjust your water usage pattern to take advantage of maximum solar gains.

Have your plumber install a flow control valve to each shower outlet, basin and sink to reduce water usage.

- **Water heater size**

Do you have the correct size water heater for your requirements?

The sizing guide in the sales literature and on the Rheem website ([www.rheem.co.nz](http://www.rheem.co.nz)) suggests average sizes that may be needed.

### **FAN CONTINUES TO RUN AFTER WATER HEATER OPERATION STOPS**

It is the normal operation of the water heater for the fan to continue running after heating of the water is finished. The fan may run for up to six minutes after the burners extinguish, to prepare for the next ignition.



### CLOUDS OF WHITE 'VAPOUR' FROM THE FLUE TERMINAL

During the heating cycle, it is not unusual to see water vapour clouds steaming from the flue terminal, particularly on cold days. This is normal operation of the water heater.

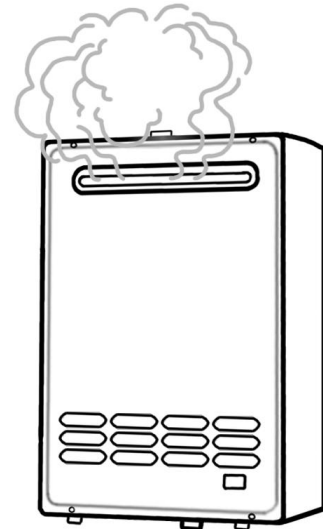

### PRESSURE RELIEF VALVE DISCHARGING

A pressure relief valve is incorporated into the water heater controls. This valve protects the water heater, by allowing water to escape, in the event of excessive pressure build up in the waterways.

- **Normal operation**

A small volume of water may discharge from the bottom of the water heater when a hot tap is suddenly closed.

- **Continuous dribble**

A continuous dribble may indicate the water supply pressure is above the design pressure for the water heater. If so, a pressure limiting valve must be installed on the cold water supply pipe to the water heater (refer to "[Mains Water Supply](#)" on page 44).

### ERROR CODE

The water heater provides a diagnostic error code in the event of an interruption to its operation. The error code is displayed on the controller(s) (if installed) and on the OK MONITOR on the front of the water heater as a numerical value. If an error code appears:

- Close the hot tap, turn off the controller(s) and switch off the electrical supply to the water heater.
- Check the gas isolation valve at the gas inlet to the water heater is fully open.
- Wait 5 minutes, then switch on the electrical supply to the water heater, turn on a controller and open a hot tap.

If the error code persists, take note of the numerical code, turn off the hot tap and turn off the controller(s). Phone your nearest Rheem Service Centre to arrange for inspection.



### HIGH GAS BILLS

Should you at any time, feel your gas account is too high, we suggest you check the following points:

- Is one outlet (especially the shower) using more hot water than you think?

Carefully review the family's hot water usage. Inexpensive flow control valves can be easily fitted to the shower outlets to reduce water usage.

- Is the gas booster water heater operating too frequently?

Refer to "[Gas Booster Operating Too Frequently](#)" on page 40.

- Consider recent changes to your hot water usage pattern and check if there has been any increase in tariffs since your previous account.



**IF YOU HAVE CHECKED ALL THE FOREGOING AND STILL BELIEVE YOU NEED ASSISTANCE, CALL YOUR NEAREST RHEEM SERVICE CENTRE.**

---

## INSTALLATION – WATER HEATER

---

**THIS WATER HEATER IS FOR OUTDOOR INSTALLATION ONLY.  
THIS WATER HEATER IS NOT SUITABLE FOR POOL HEATING.  
Check the water heater is suitable for the gas type available.  
(refer to the rating label on the water heater)**

The 874 series of water heater may be installed as an in-series gas booster water heater to a solar preheat water heater. For information relating to the function and operation of the solar water heater, refer to the Owner's Guide and Installation Instructions supplied with the solar water heater.

The installation must comply with these installation instructions and with the requirements of Standards AS/NZS 3500.4, NZS 5261 or AS/NZS 5601 and all local codes and regulatory authority requirements.

All packaging must be removed from the water heater prior to its installation.

### WATER HEATER LOCATION

The water heater should be installed close to the most frequently used outlet and its position chosen with safety and service in mind. If this water heater is part of a solar water heater system, it should also be installed close to the solar storage tank. Make sure people (particularly children) will not touch the flue terminal. The flue terminal and air inlet must be clear of obstructions and shrubbery.

Clearance must be allowed for servicing of the water heater. The water heater must be accessible without the use of a ladder or scaffold. Make sure the entire front panel can be removed for service. You must be able to read the information on the rating plate. Remember you may have to take the entire water heater out later for servicing.

This water heater must be installed vertically upright with the water, gas and power connections on the underside, pointing toward the ground. The back of the water heater can be either against a wall or supported by a frame. The water heater must be secured to the wall or frame using suitable mounting screws, two each at the top and bottom of the unit ([refer to page 49 for mounting hole positions](#)). Alternatively the water heater can be recessed into a wall ([refer to "Recess Installation" on page 43](#)).



- For a single water heater installation, refer to the diagram on page 52.

The water heater must not be installed in an area with a corrosive atmosphere where chemicals are stored or where aerosol propellants are released. Remember the air may be safe to breathe, but when it goes through a flame, chemical changes take place which may attack the water heater.

A secondary flue is not required. The water heater must not be installed indoors or in a confined space.

---

As a guide the following requirements extracted from the New Zealand Gas Installations Standard NZS 5261, must be observed.

- At least 300 mm between the top of the flue terminal and the eaves.
- At least 500 mm between the flue terminal and the edge of any opening into the building, measured horizontally along the wall.
- At least 300 mm between the flue terminal and a return wall or external corner, measured horizontally along the wall.
- At least 1500 mm between the top of the flue terminal and below any openable window measured vertically.
- At least 1500 mm between the flue terminal and any opening into a building, in the direction of the flue discharge.
- At least 500 mm between the flue terminal and a fence, wall or other obstruction, in the direction of the flue discharge.

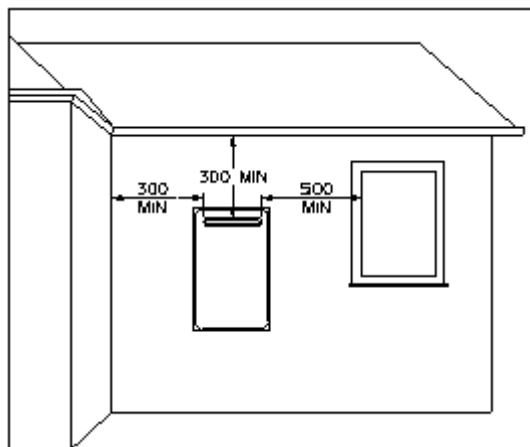

### PIPE COVER

The pipe work to the water heater can be housed within a pipe cover. A pipe cover kit (PN 317694) is available for such an installation. Refer to the installation instructions which accompany the pipe cover kit.

### RECESS INSTALLATION

The water heater can be installed recessed into a wall. A recess box (PN 317695) is available for such an installation. An additional rating label is supplied with the water heater. This must be placed on either the front panel of the water heater or to another position which is visible when the water heater is installed. Refer to the installation instructions which accompany the recess box kit for information on its installation.

### FROST PROTECTION

The water heater has a frost protection system. The frost protection system will protect the water heater from damage, by preventing ice forming in the waterways of the water heater, in the event of freezing conditions occurring.

The frost protection system will be rendered inoperable if electrical power is not available at the water heater. Damage to the water heater caused by freezing of the pipe work to or from the water heater is not covered under warranty. Refer to AS/NZS 3500.4 for precautions to be taken for installations in frost prone areas. The water heater is not suitable for installation in areas where the ambient temperature falls below -20°C (including wind chill factor).

The cold water line to the water heater must be insulated with suitable thickness insulation if freezing conditions are likely to occur. The insulation must be fitted to the underside of the water heater and be weatherproof and UV resistant if exposed.

---

## MAINS WATER SUPPLY

Where the mains water supply pressure exceeds that shown in the table below, an approved pressure limiting valve that does not have non return valve characteristics (such as an RMC PSL series valve) is required and should be fitted as shown in the installation diagram ([refer to page 52](#)).

Model	874627 872627
Relief valve setting	1750 kPa
Max. mains supply pressure	1000 kPa
Min. mains supply pressure *	140 kPa

\* minimum water supply pressure required to achieve the rated flow and performance

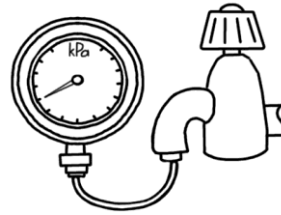

### Notes:

- It is not recommended to install this water heater with a low pressure water supply.
- A minimum water supply pressure of 140 kPa is required to achieve the rated flow and performance of the water heater.
- If this water heater is installed as a gas booster for a solar water heater, the maximum water supply pressure to the solar preheat water heater, without an expansion control valve (ECV), is generally 800 kPa, however it may be less than this for some models. Refer to the Owner's Guide and Installation Instructions supplied with the solar water heater for maximum mains supply pressure details.
- This water heater is not suitable for connection to bore water or spring water unless a water treatment device is fitted.
- If sludge or foreign matter is present in the water supply, it is recommended a suitable filter be incorporated in the cold water line to the water heater.
- Refer to "[Water Supplies](#)" on page 74.

## HOT WATER DELIVERY

This water heater can deliver water at temperatures which can cause scalding.

It is necessary and we recommend that a temperature limiting device be fitted between an 874 or 872 series water heater and the hot water outlets in any ablution and public areas such as a bathroom, ensuite or public amenities, to reduce the risk of scalding. The installing plumber may have a legal obligation to ensure the installation of this water heater meets the delivery water temperature requirements of AS/NZS 3500.4 so that scalding water temperatures are not delivered to a bathroom, ensuite or other ablution or public area.

The temperature limiting device used with an electronic continuous flow gas water heater should have:

- a specified minimum temperature differential between the hot water inlet and the tempered water outlet of no greater than 10°C, and
- a specified maximum permitted pressure variation in the supply between the hot water inlet and the cold water inlet of no less than 15%.

Where a temperature limiting device is installed adjacent to the water heater, the cold water line to the temperature limiting device can be branched off the cold water line either before or after the isolation valve and pressure limiting valve to the water heater.

If a pressure limiting valve is installed on the cold water line to the water heater and the cold water line to a temperature limiting device branches off before this valve or from another cold water line in the premises, then a pressure limiting valve of an equal pressure setting may be required prior to the temperature limiting device.

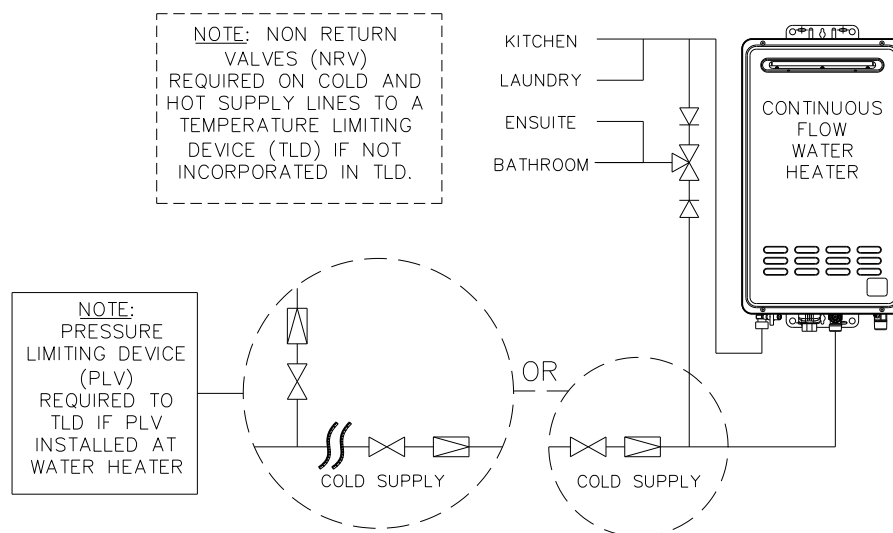

**Two Temperature Zones Using a Temperature Limiting Device**

An 874 series water heater will not deliver temperatures exceeding 55°C in accordance with AS 3498. There is no statutory requirement in AS/NZS 3500.4 to fit a temperature limiting device if this water heater is installed in other than an early childhood centre, school, nursing home or a facility for young, aged, sick or disabled people. Refer to [“Water Temperature Diagrams”](#) on page 48.

### Gas Booster for a Solar Water Heater

The temperature limiting device used with an 874 series gas booster water heater as part of a solar water heater installation must have the additional capability of receiving a hot water supply temperature of up to 99°C if the solar preheat water heater does not have an over temperature protection system to limit the water to no greater than 90°C.

**⚠ Warning:** Temperature controllers **must not** be fitted to this water heater as part of a solar water heater system (874 series) because water at a temperature much higher than the controller setting can be delivered. If a solar preheater has been installed to an existing water heater installation, then all controllers **must be** disconnected and removed.

Where a temperature limiting device is installed adjacent to the gas booster water heater, the cold water line to the temperature limiting device can be branched off the cold water line either before or after the isolation valve and pressure limiting valve to the solar storage tank, but it **MUST BE** before the non return valve prior to an open circuit direct system. The cold water line to the temperature limiting device can be branched off the cold water line either before or after the non return valve prior to a closed circuit indirect system. If an expansion control valve is required, it must always be installed after the non return valve and be the last valve prior to the solar storage tank.

**⚠ Warning:** A non return valve **MUST BE** installed on the cold water line to the solar storage tank **AFTER** the cold water branch to a temperature limiting device prior to an open circuit direct system. Due to the higher water temperatures generated under certain conditions in the solar collectors of an open circuit direct solar water heater, an additional effective back-flow prevention device also should be used as an extra safeguard. Valve manufacturer RMC recommends Dual Check Valve model N7150, as being suitable for this application.

If a combination isolation valve and non return valve (duo or trio valve) is installed on the cold water line to an open circuit direct solar water heater and the cold water line to the temperature limiting device branches off after this valve, then a second non return valve must be installed between the cold water branch and the solar storage tank. Due to the higher water temperatures generated under certain conditions in the solar collectors of an open circuit direct pumped solar water heater, an effective back-flow prevention device should be used as the second non return valve as an extra safeguard. Valve manufacturer RMC recommends Dual Check Valve model N7150, as being suitable for this application.

If a pressure limiting valve is installed on the cold water line to the solar water heater and the cold water line to a temperature limiting device branches off before this valve or from another cold water line in the premises, then a pressure limiting valve of an equal pressure setting may be required prior to the temperature limiting device.

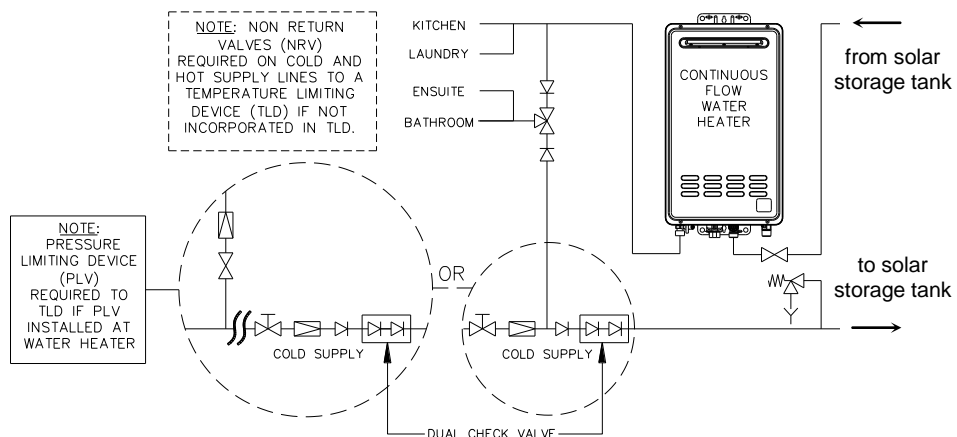

**Gas Booster for Open Circuit Direct Solar Preheater Installation  
Two Temperature Zones Using a Temperature Limiting Device**

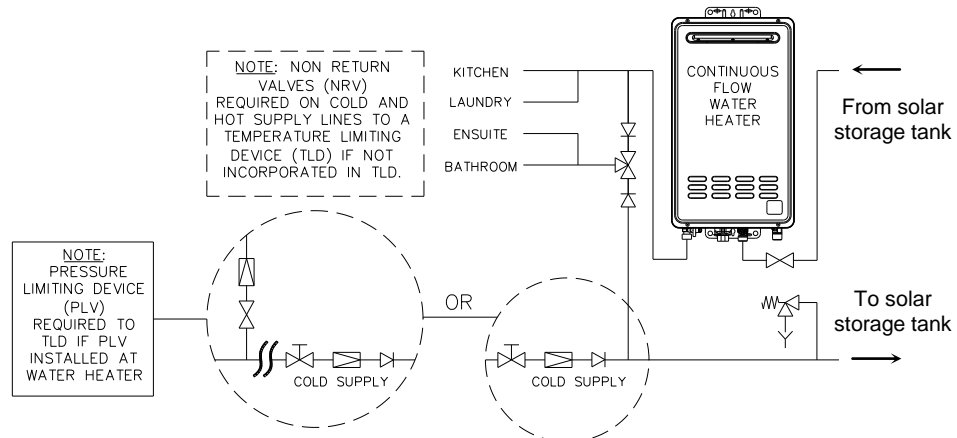

**Gas Booster for Closed Circuit Solar Preheater Installation  
Two Temperature Zones Using a Temperature Limiting Device**

---

## CIRCULATED HOT WATER FLOW AND RETURN SYSTEM

The Rheem 874 and 872 series continuous flow water heaters can be installed as part of a circulated hot water flow and return system in a building.

### Notes:

- the preset outlet temperature setting of the water heater must be set to at least 60°C.
- temperature controllers can not be installed with a water heater as part of a circulated hot water flow and return system.

### Temperature Limiting Device

A temperature limiting device cannot be installed in circulated hot water flow and return pipe work. The tempered water from a temperature limiting device cannot be circulated. Where a circulated hot water flow and return system is required in a building, a temperature limiting device can only be installed on a dead leg, branching off the circulated hot water flow and return pipe.

If circulated tempered water were to be returned back to the water heater, depending on the location of the return line connection on the water supply line to the water heater, then either:

- water will be supplied to the cold water inlet of the temperature limiting device at a temperature exceeding the maximum recommended water supply temperature, or
- when the hot taps are closed no water will be supplied to the cold water inlet of the temperature limiting device whilst hot water will continue to be supplied to the hot water inlet of the temperature limiting device.

These conditions may result in either water at a temperature exceeding the requirements of AS/NZS 3500.4 being delivered to the hot water outlets in the ablution areas, or the device closing completely and not delivering water at all, or the device failing. Under either condition, the operation and performance of the device cannot be guaranteed.

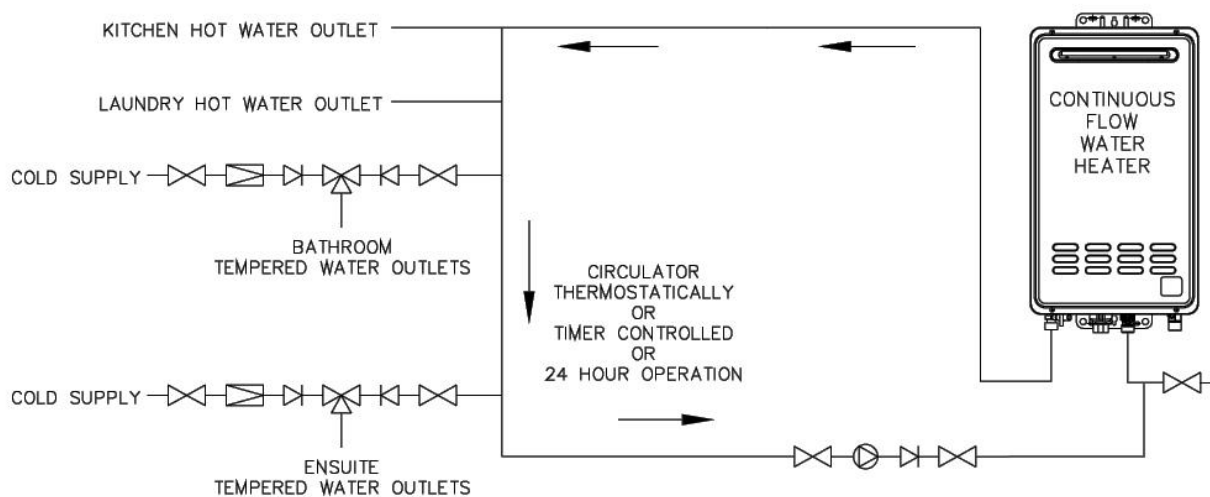

**Recirculated Hot Water Flow and Return - Continuous flow Gas Water Heater**

## REDUCING HEAT LOSSES

The hot water line from the water heater and the pipe work between the solar storage tank, if one is installed, and the gas booster water heater must be insulated in accordance with the requirements of AS/NZS 3500.4. The insulation must be weatherproof and UV resistant if exposed. The insulation must be fitted up to the connections on the both the underside of the water heater and the solar storage tank.

## WATER TEMPERATURE DIAGRAMS

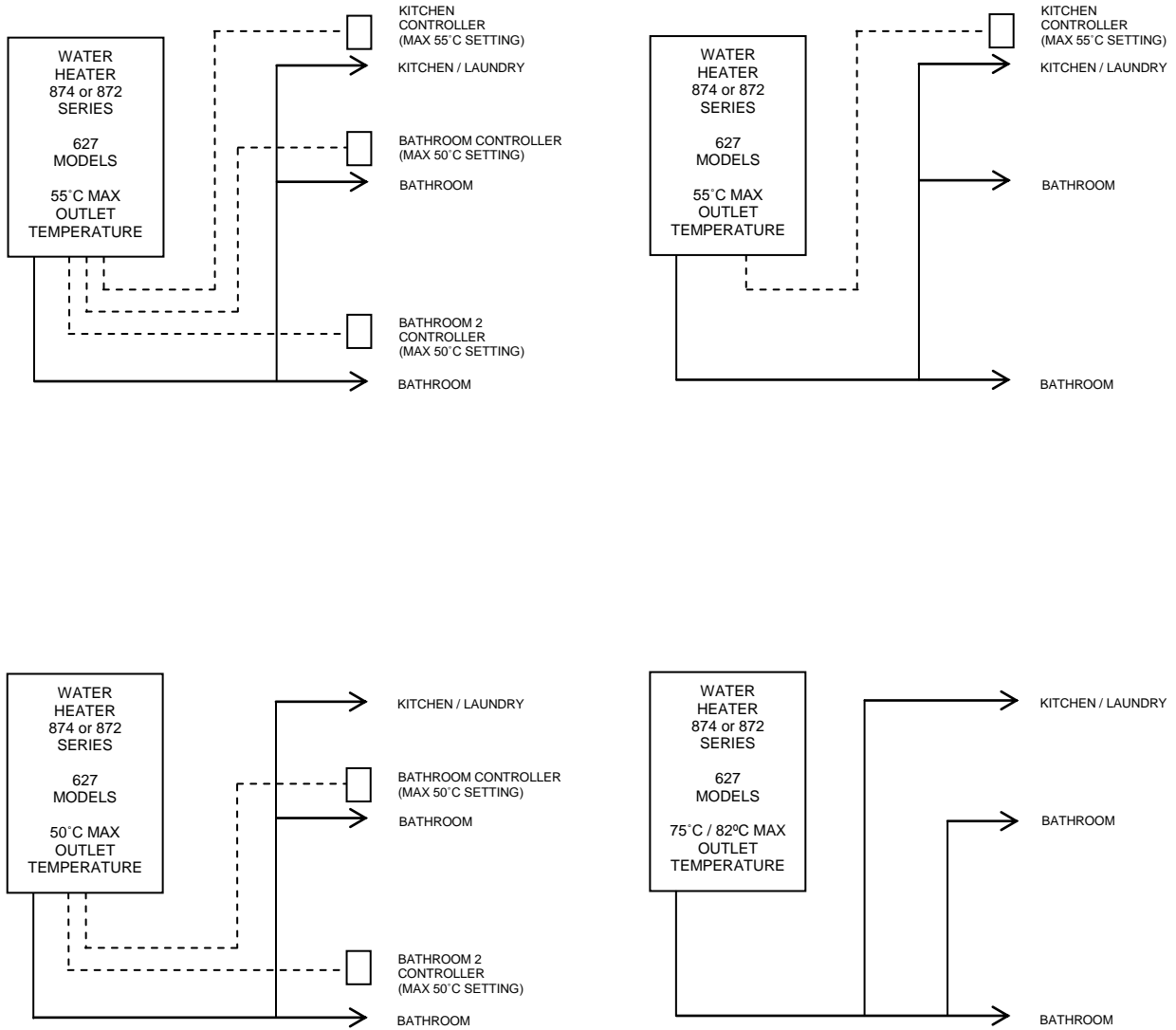

### 874 and 872 Series - No Controllers

#### Notes:

- Temperature Limiting Devices – refer to “Hot Water Delivery” on page 45.
- Factory preset outlet temperature setting is:
  - 874 series      55°C
  - 872 series      55°C



## Dimensions And Technical Data

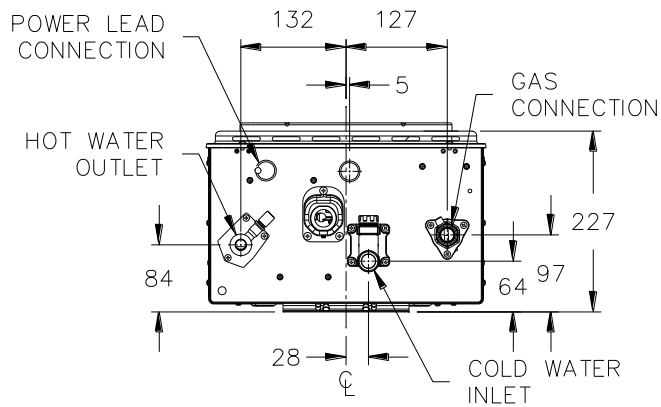
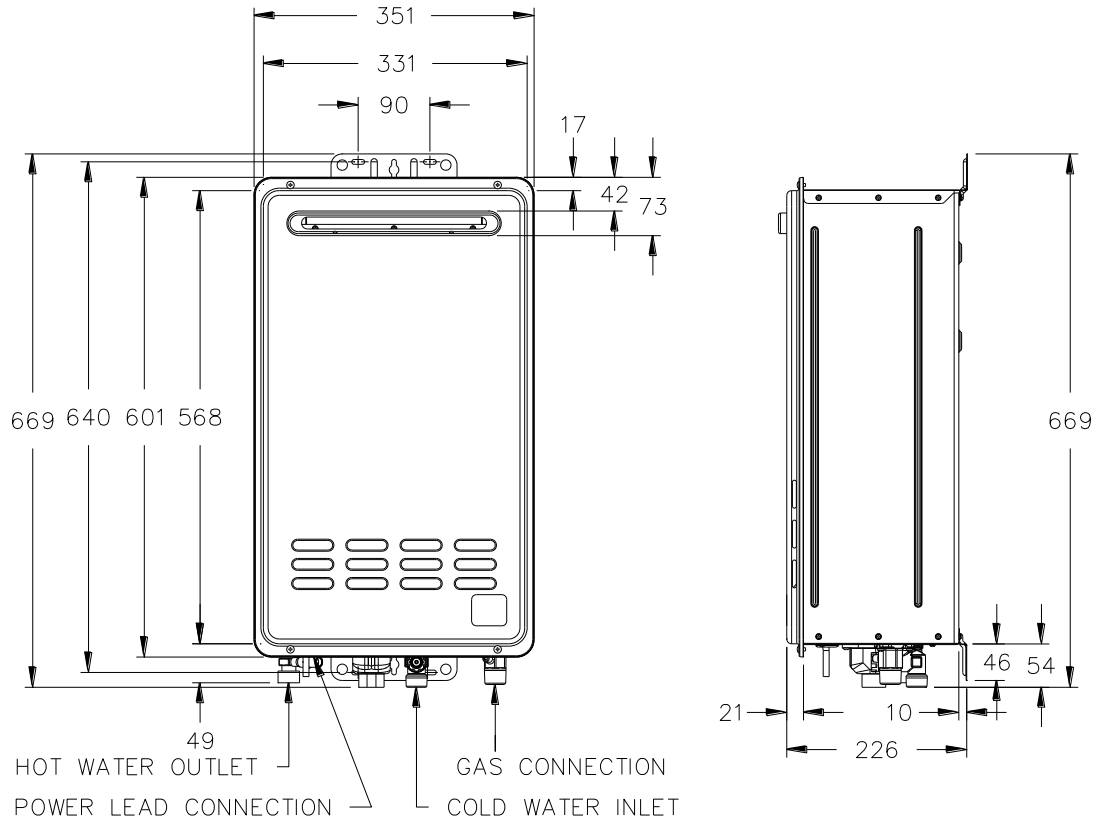

Model		874627	872627
<b>Rated delivery</b> (@ 40°C rise)	litres / min	16.9	16.9
<b>Recovery</b> (@ 25°C rise)	litres / min	27	27
<b>Weight</b> (Empty)	kg	24	24

Gas Details	Hourly Gas Consumption (MJ)	Min Gas Pressure (kPa)	Test Point Gas Pressure (kPa)		Max Gas Pressure (kPa)
			minimum	maximum	
Model	627	627	627	627	627
Natural	205	1.13	0.193	0.905	3.50
LPG	205	2.75	0.277	1.340	3.50

Model numbers: N = Natural, L = LPG

Letter N or L is included in the model number, eg 874627NFZ, to denote gas type.

F = Frost protection.

Specifications are subject to change with ongoing product improvements.

---

**DIMENSIONS – STANDARD CONTROLLERS**

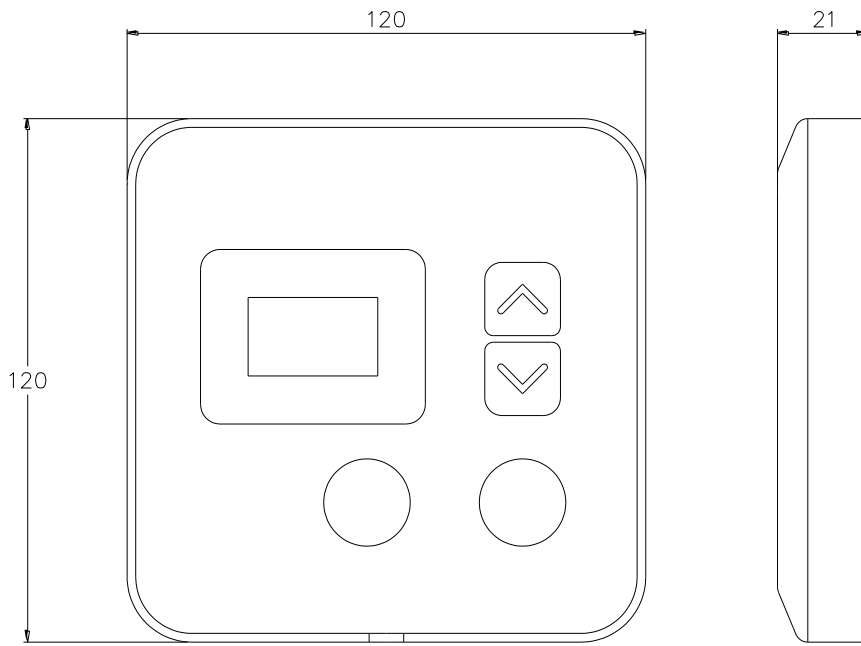

**Kitchen Controller (Standard)**

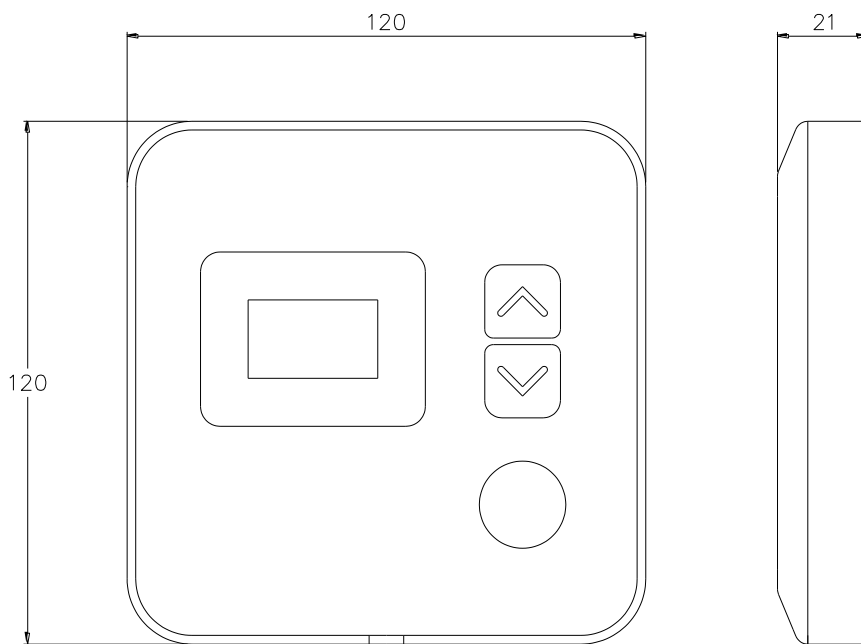

**Bathroom Controller (Standard)**

**DIMENSIONS – DELUXE CONTROLLERS**

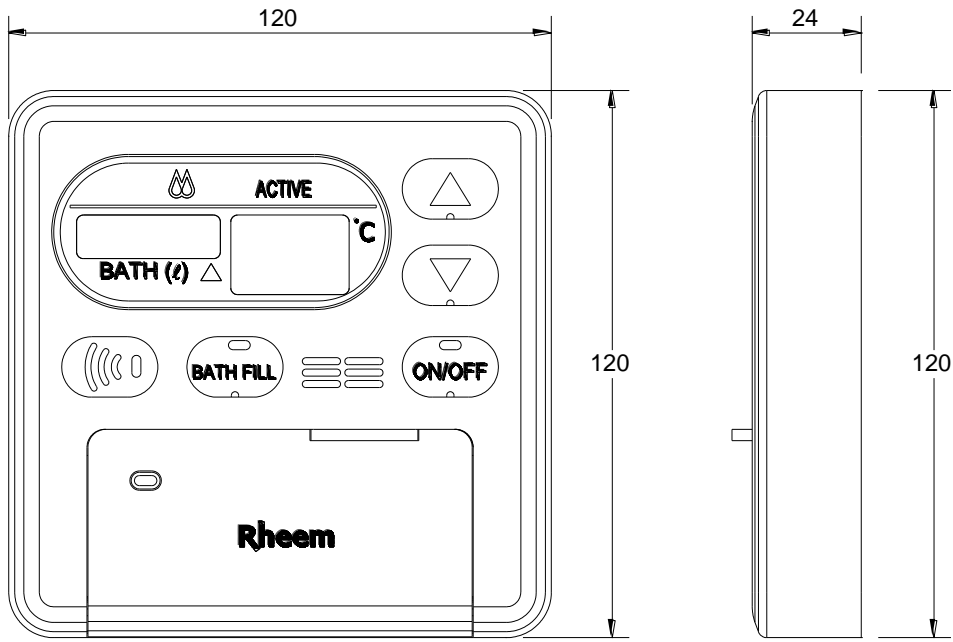

**Deluxe Controller – Cover Closed**

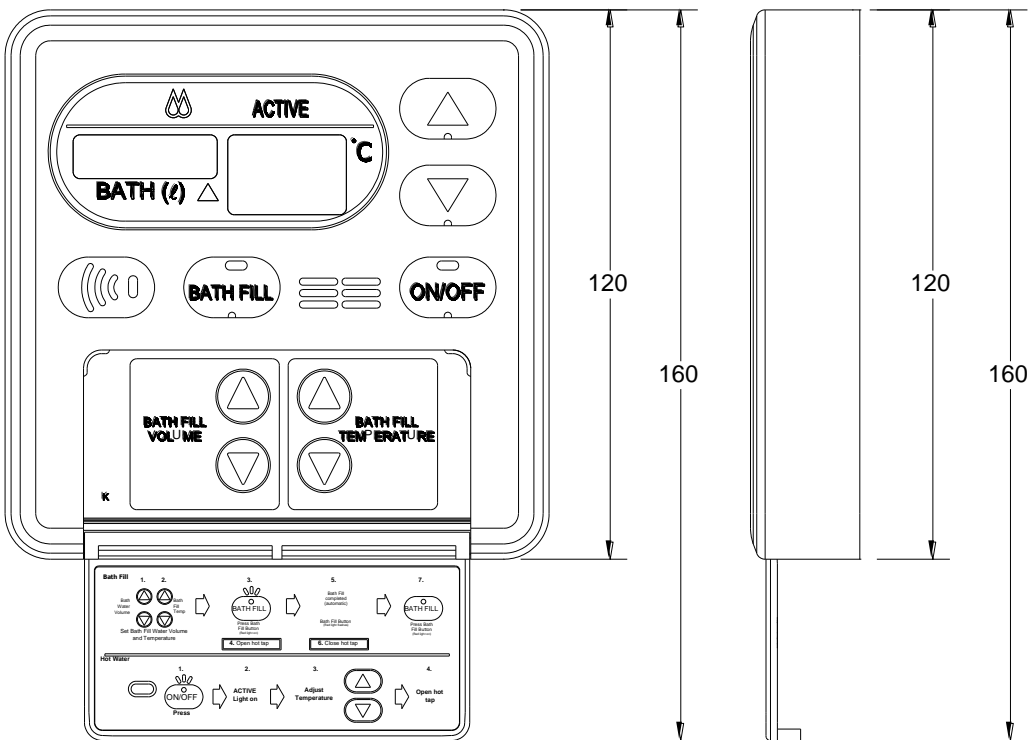

**Deluxe Controller – Cover Open**

**TYPICAL INSTALLATION – OUTDOOR LOCATION**

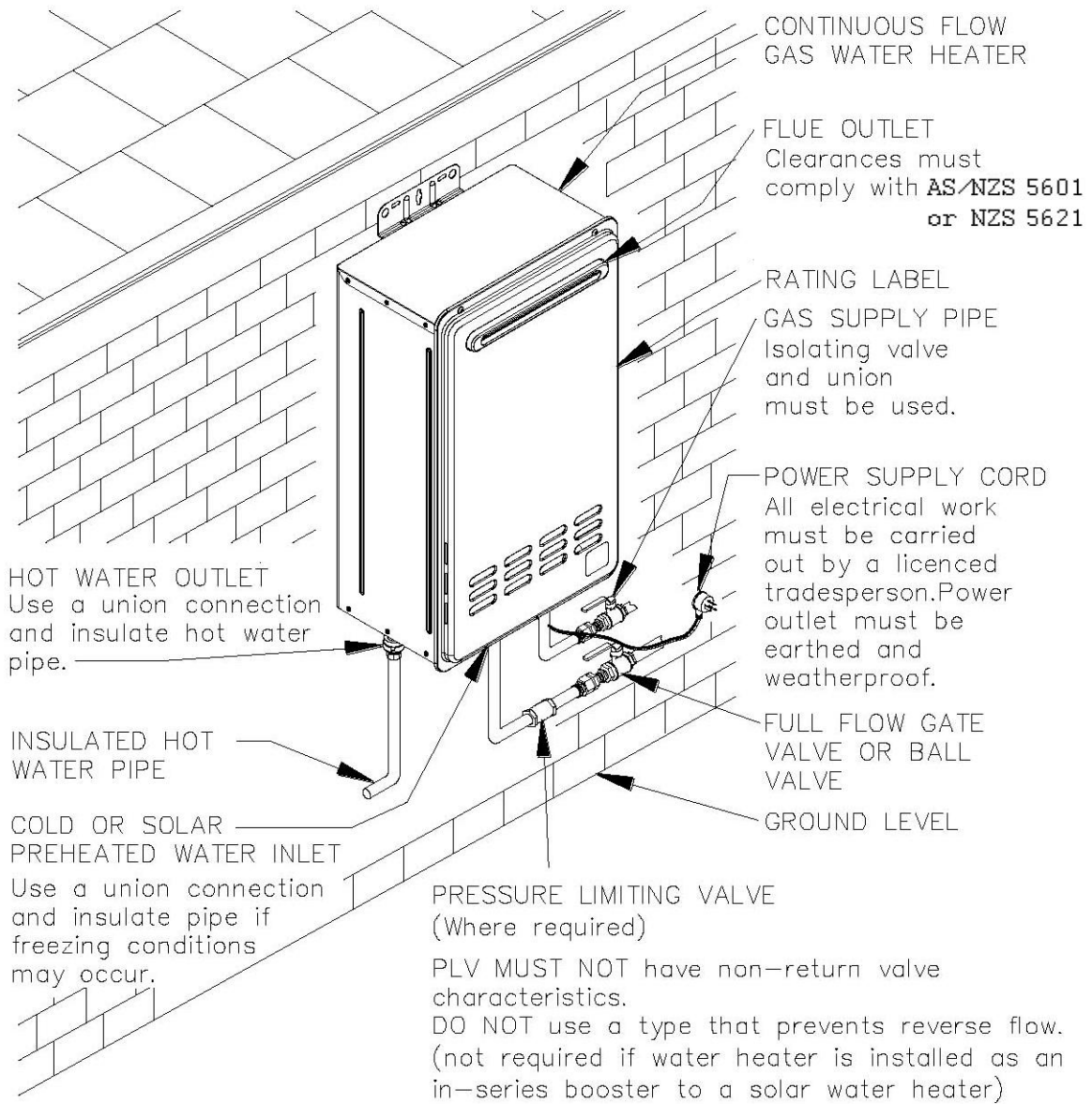

## CONNECTION SIZES

<b>Model</b>	874627
	872627
Hot water connection	R <sup>3</sup> / <sub>4</sub> /20
Cold water connection	R <sup>3</sup> / <sub>4</sub> /20
Gas inlet connection	R <sup>3</sup> / <sub>4</sub> /20

All plumbing work must be carried out by a qualified person and in accordance with the National Plumbing Standard AS/NZS 3500.4 and local authority requirements.

All gas work must be carried out by a qualified person and in accordance with the New Zealand Gas Installations Standard NZS 5261 or AS/NZS 5601 and local authority requirements.

## WATER INLET AND OUTLET

All pipe work must be cleared of foreign matter before connection and purged before attempting to operate the water heater. All olive compression fittings must use brass or copper olives. Use thread sealing tape or approved thread sealant on all fittings.

A full flow gate valve or ball valve must be installed on the cold water line or solar preheat water line to the water heater. **A non return valve or stop tap must not be installed.** An acceptable arrangement is shown in the diagram. Refer also to “Hot Water Delivery” on page 45 and to “Mains Water Supply” on page 44.

A disconnection union must always be provided at the cold water inlet and hot water outlet on the water heater to allow for disconnection of the water heater.

Insulation used on the cold and hot water lines must extend up to the cold water inlet and hot water outlet of the water heater.

## Notes:

- It is essential all pipe connections be correctly aligned, otherwise component connections within the water heater may be strained and/or components themselves misaligned. It is recommended also, wherever possible, pipe connections be made at the water heater first and final pipe runs be made in soft copper pipe to allow some adjustment for misalignment.
- Use the spanner flats on the water heater fittings and take care to avoid twisting the water inlet and outlet pipes inside the jacket.
- 874 series gas booster water heaters **do not** need to be installed with a solar bypass valve.
- The maximum supply temperature to the water heater when used as an in-series gas booster for a solar preheat water heater is 80°C.**

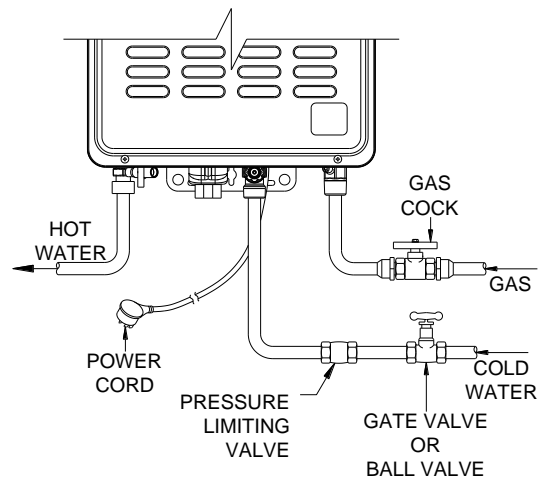

**Gas Water Heater  
Cold and Hot Water Connection Details**

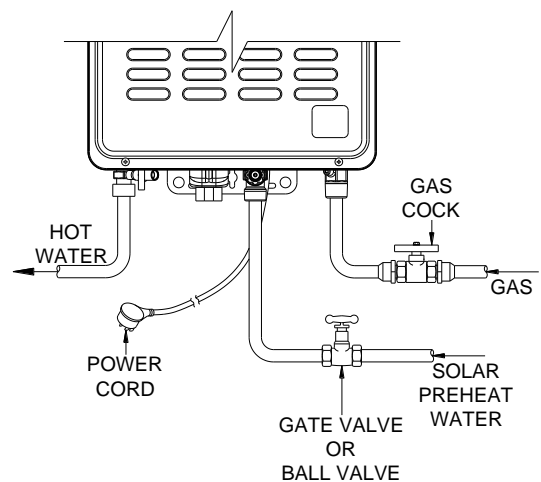

**Gas Booster for a Solar Preheater  
Solar Preheat and Hot Water**

---

## PIPE SIZES

The pipe sizing for hot water supply systems should be carried out by persons competent to do so, choosing the most suitable pipe size to ensure adequate flow for each individual application. Reference to the technical specifications of the water heater and local regulatory authority requirements must be made.

To achieve true mains pressure operation, the cold water line to the water heater should be the same size or bigger than the hot water line from the water heater.

The minimum recommended cold pipe or solar preheat pipe and hot pipe size is DN20.

## IN-SERIES BOOST WATER HEATER

The pipe work between the solar storage tank (if one is installed) and the gas booster water heater has a minimum recommended pipe size of DN20, **MUST BE** of copper and be fully insulated in accordance with the requirements of AS/NZS 3500.4. The insulation must be weatherproof and UV resistant if exposed. The insulation must be fitted up to the connections on both the solar storage tank and the gas booster water heater. A full flow isolation valve must be installed on the water line to the gas booster water heater.

## GAS INLET

The gas connection is made at the underside of the water heater. The pipe work must be cleared of foreign matter before connection and purged before attempting to operate the water heater. An isolation valve and disconnection union must be installed to allow servicing and removal of the water heater (refer to the [diagram on page 53](#)).

**Note:** Refer to the Gas Installations Standard NZS 5261 or AS/NZS 5601 for the correct method of sizing the gas supply pipe to the water heater. The pipe size selection must take into account the high gas input of this water heater ([refer to table on page 49](#)) as well as all of the other gas appliances in the premises.

**⚠ Warning:** Always isolate the water heater before pressure testing the gas supply system. Disconnect the water heater after the isolation valve to prevent the risk of serious damage to the gas control. Warranty does not cover damage of any nature resulting from failure to observe this precaution. Refer to rating label for gas types and pressures.

---

## CONNECTIONS – ELECTRICAL

---

All electrical work and permanent wiring must be carried out by a qualified person and in accordance with the Wiring Rules AS/NZS 3000 and local authority requirements.

**⚠ Warning:** Temperature controllers **must not** be fitted to this water heater (874 series) as part of a solar water heater system because water at a temperature much higher than the controller setting can be delivered. If a solar preheater has been installed to an existing water heater installation, then all controllers **must be** disconnected and removed.

The water heater is supplied with a 1.8 metre lead and plug and requires a weatherproof 240 V 50 Hz general purpose outlet (GPO) to be located within 1.2 metres of the installation. The GPO must be clear of the flue exhaust, draining water, gas supply pipe and water connections.

The power consumption of the water heater is:

Component	Power consumption	Comments
874627 and 872627	80 Watts	Burner on, anti frost device inactive
	175 Watts	Burner on, anti frost device active

The water heater will only operate on a sine wave at 50 Hz. Devices generating a square wave cannot be used to supply power to the water heater.

# EZ-LINK SYSTEM DUAL INSTALLATION

The EZ-Link™ system is designed to electronically control two continuous flow gas water heaters and have them operate as one. One or both water heaters may be in operation, depending upon the hot water demand. The second water heater will only operate when the hot water demand exceeds the capacity of the first water heater to supply.

The EZ-Link system is suitable for installation with Rheem 864 and 862 series continuous flow gas water heaters. The Ez-Link Kit PN 290141 is required for the installation.

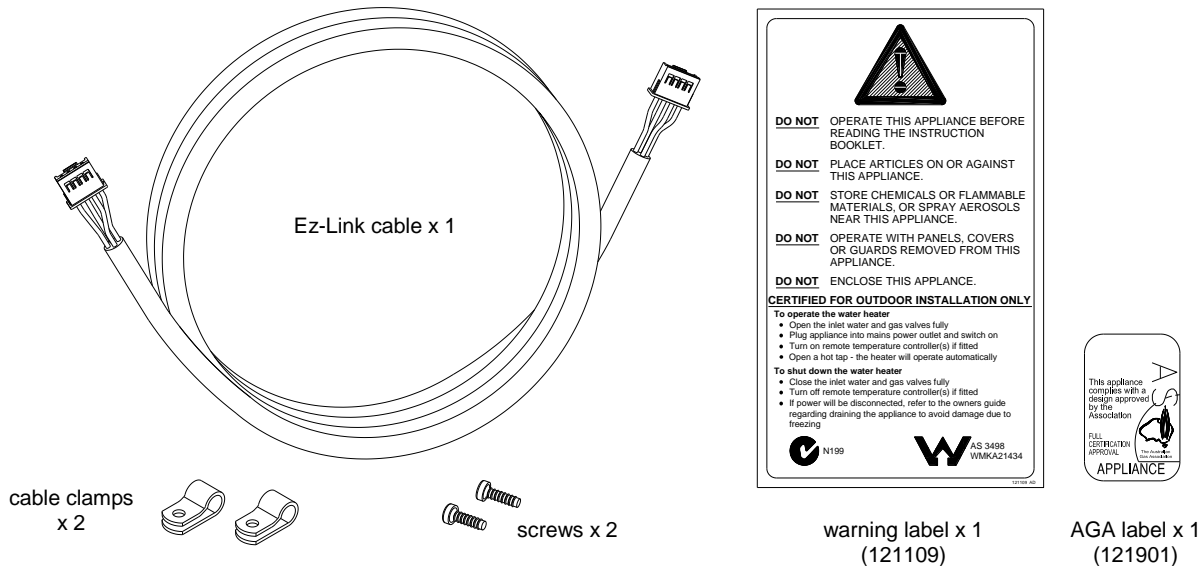

### Ez-Link Kit – PN 290141

**Notes:**

- Only two continuous flow gas water heaters can be installed with an Ez-Link system.
- The Ez-Link system will vary the start up sequence of the two water heaters.
- The two continuous flow water heaters must be of the same model. The performance of two different model water heaters manifolded together cannot be guaranteed.
- A temperature controller is not required to be installed with the EZ-Link system.
- If required, the controller can be either a standard or deluxe controller.
- A maximum temperature of 55°C if a kitchen controller is used.

**⚠ Warning:** Two continuous flow water heaters manifolded together with an Ez-Link system installed cannot be used as an in-series gas booster system to a solar water heater installation. Temperature controllers **must not** be fitted to a water heater as part of a solar water heater system because water at a temperature much higher than the controller setting can be delivered.



## DUAL INSTALLATION

Install two continuous flow water heaters of the same model in a parallel plumbing arrangement. It is good practice, but not essential, to install the two water heaters in an Equa-Flow<sup>®</sup> manifold plumbing arrangement. There are basic installation requirements which must be followed:

1. The pipe work must be sized to meet the requirements of both AS/NZS 3500.4 and the application. It is recommended to use minimum DN25 pipe for the cold water line, cold and hot headers and hot water line and DN20 for the cold and hot water branch lines of each water heater.
2. A full flow gate valve or ball valve must be installed on the cold water line to the system. A non return valve or stop tap must not be installed.
3. A full flow gate valve or ball valve (not a stop tap) should be installed on both the cold water branch and hot water branch of each water heater.
4. An isolation valve must be installed on the gas branch of each water heater.
5. Non return valves or pressure limiting valves must not be installed on the branch lines to the water heaters.
6. All fittings, valves and branch lines should be matched sets to each of the water heaters.
7. Sufficient space must be left to enable access, servicing or removal of either water heater.

Refer to the '[Typical Two Unit Manifold with Ez-Link Connection](#)' diagram on page 59 for installation and plant layout details.

## LABELS

A warning label (121109) and an AGA approval label (121901) are supplied in the Ez-Link kit. Where the two water heaters are installed close together and the warning label and AGA approval label on the inside face of the right hand water heater cannot be read, it is necessary to adhere the two labels supplied to the right-hand face of the water heater.

8. Place the warning label below the rating label.
9. Place the AGA approval label beside the barcode label.

Refer to the '[Label Positioning](#)' diagram adjacent for the position of the two labels to be adhered to the water heater.

A second rating label is attached to the inside of the front cover. This can be referenced to determine details of the left hand water heater.

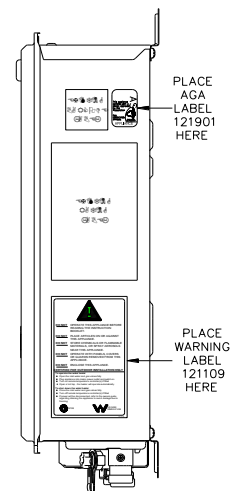

**Label Positioning**

## TEMPERATURE CONTROLLER

A temperature controller is not required to be installed with the EZ-Link system. If fitted, the controller can be either a standard or Deluxe controller.

If required connect a temperature controller to one only of the two water heaters. Up to three temperature controllers of the same family can be installed to this water heater. Refer to "[Installation – Controllers](#)" on page 60.

The water heater connected with the temperature controller(s) will become the "master" water heater. The installed temperature controller(s) will control the temperature and functionality of both water heaters. The maximum outlet temperature of the water heaters will be limited by the maximum temperature setting of the temperature controller.

A controller should only be installed if two continuous flow gas water heaters have been Ez-Linked together and they are not part of a circulated hot water flow and return system in a building. Refer to "[Circulated Hot Water Flow And Return System](#)" on page 47.

---

## EZ-LINK CABLE CONNECTION

The references in steps 14 to 17 are to the 'Control Board with Ez-Link Connection' diagram on page 59. To connect the Ez-Link cable to the water heaters:

10. Close any hot taps and ensure the burners on both water heaters are not operating.
11. Switch off the electrical supply at the power outlet to each water heater.
12. Remove the screws holding the front panel to the jacket on each water heater.
13. Gently disengage the front panel and pull forward to remove from each water heater.
14. Connect one end of the EZ-Link cable to the first water heater.
  - Draw the cable through the cable grommet on the underside of the water heater.
  - Plug the cable into the four pin connector located immediately below the MIN button, toward the upper right hand corner of the Control Board (refer to the [Control Board](#) diagram).

The connector will only fit one way.
  - Press until the connector snaps into place.
  - Secure the EZ-Link cable with the clamp and screw provided to the top right of the Control Board (refer to the [Control Board](#) diagram).
15. Switch DIP SWITCH 4 to the on (up) position on the first water heater (refer to the [Control Board](#) diagram). **Note:** This dip switch is on the DIP 1 set of dip switches.
16. Connect the other end of the EZ-Link cable to the second water heater.
  - Draw the cable through the cable grommet on the underside of the water heater.
  - Plug the cable into the four pin connector located immediately below the MIN button, toward the upper right hand corner of the Control Board (refer to the [Control Board](#) diagram).

The connector will only fit one way.
  - Press until the connector snaps into place.
  - Secure the EZ-Link cable with the clamp and screw provided to the top right of the Control Board (refer to the [Control Board](#) diagram)
17. Switch DIP SWITCH 4 to the on (up) position on the second water heater (refer to the [Control Board](#) diagram). **Note:** This dip switch is on the DIP 1 set of dip switches.
18. Refit the front panel and screws to each water heater.
19. Check the main gas isolation valve and the isolation valves at the gas inlet to each water heater are fully open.
20. Switch on the electrical supply at the power outlet to the water heater. If fitted, turn on the controller by pressing the on / off button. The light in the on / off button and the priority light (standard controller) or ACTIVE light (Deluxe controller) will both glow.
21. Open a hot tap.

The first water heater and depending upon the flow from the hot tap, the second water heater will operate automatically.
22. Increase the hot water flow by turning on an additional hot tap(s).

Check to ensure the flow from each connected hot tap is sufficient to operate both water heaters.

The minimum operating flow rate for each water heater is 3.0 litres per minute.
23. Turn off the hot taps.

Refer to "[Commissioning](#)" on page 67 for details on completing the installation.

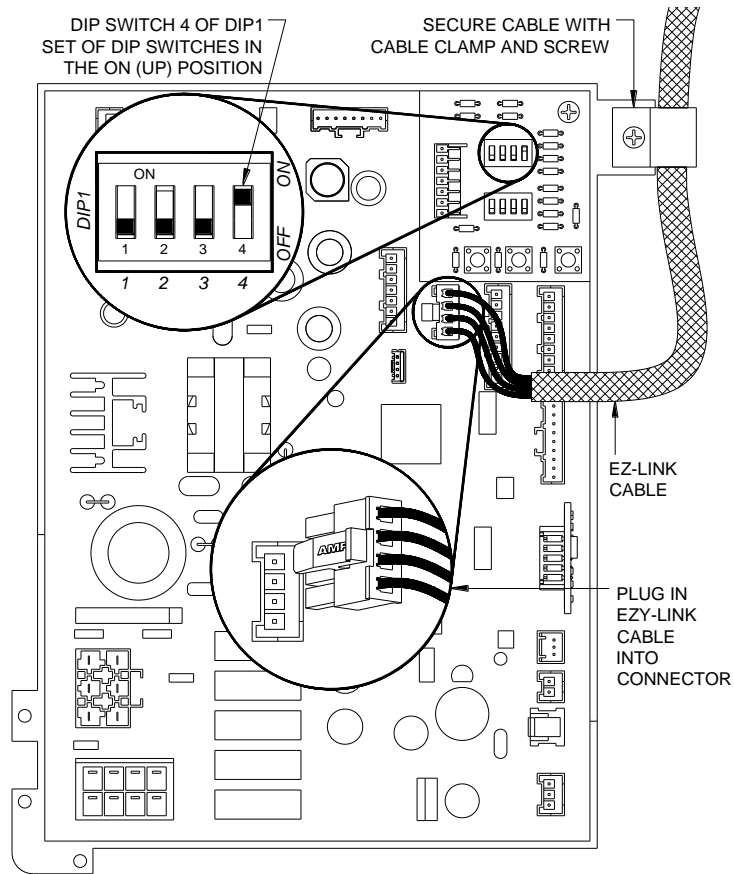

**Control Board with Ez-Link Connection**

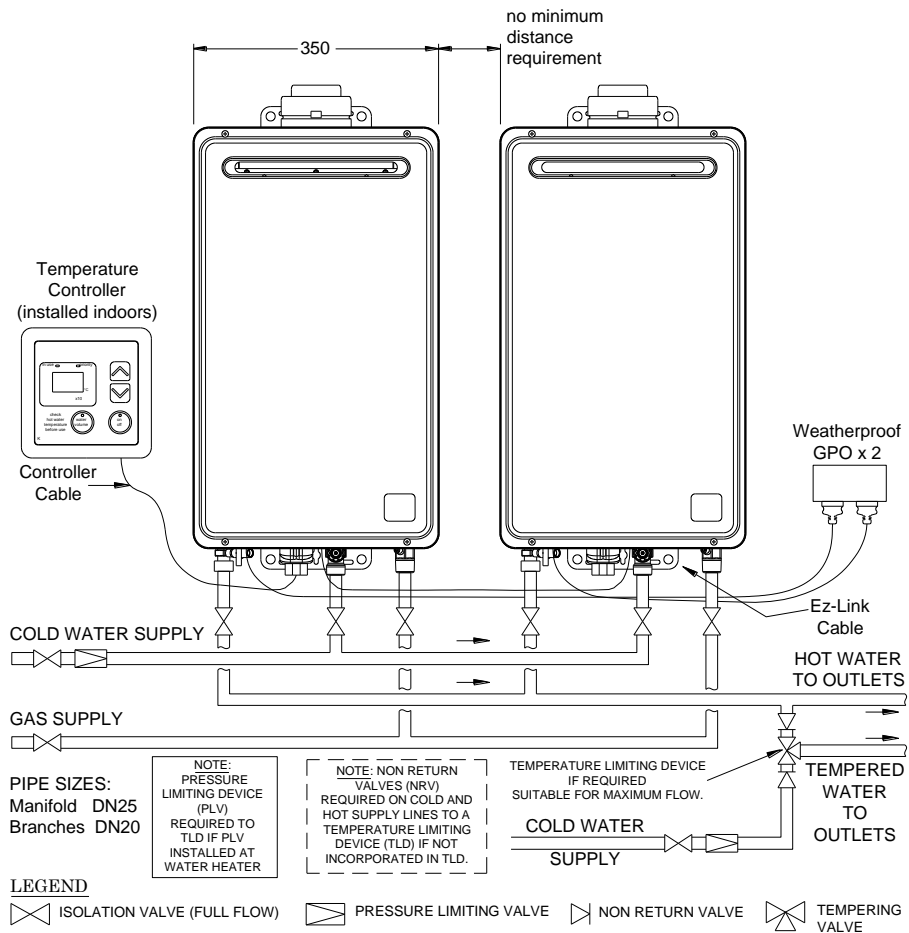

**Typical Two Unit Manifold with Ez-Link Connection**

---

## INSTALLATION – CONTROLLERS

---

### CONTROLLERS

The Rheem 874 & 872 series can be installed with Rheem controllers to enable the user to control the temperature of the delivered water from the outlet of the water heater.

There are two families of Rheem controllers suitable for installation with this water heater. These are the standard controllers and the Deluxe controllers.

#### Standard Controllers

There are three types of standard controller. They are the Kitchen controller (Rheem PN A299853), Bathroom1 controller (Rheem PN A299854) and the Bathroom2 controller (Rheem PN A299855).

The standard controllers are suitable for use on all 874 and 872 models.

The standard controllers are identified by a 'K' (Kitchen controller), 'B1' (Bathroom1 controller) or 'B2' (Bathroom2 controller) located on the front bottom left hand corner of the standard controller.

#### Deluxe Controllers

There are three types of Deluxe controller. They are the Kitchen Deluxe controller (Rheem PN A299861), Bathroom1 Deluxe controller (Rheem PN A299862) and the Bathroom2 Deluxe controller (Rheem PN A299863).

The Deluxe controllers are suitable for use on all 874 & 872 models.

The Deluxe controllers are identified by a 'K' (Kitchen Deluxe controller), 'B1' (Bathroom1 Deluxe controller) or 'B2' (Bathroom2 Deluxe controller), located under the front panel, to the bottom left hand corner adjacent to the BATH FILL VOLUME label.

The standard and Deluxe controllers are designed to be hard wired into the water heater using either the Kitchen controller cable (Rheem PN A299856) or the Bathroom controller cable (Rheem PN A299857).

#### Notes:

- Where more than one controller is installed, the second or third controller must be of the same family.
- A standard controller can only be installed with another standard controller(s) and a Deluxe controller can only be installed with another Deluxe controller(s). A standard controller(s) and a Deluxe controller(s) cannot be connected to the same water heater.
- One, two or three controllers can be installed. Only one of each type of controller can be connected to the water heater. Therefore, a maximum of three controllers only can be connected to each water heater.
- A Bathroom2 controller can only be installed if a Bathroom1 controller is installed and a Bathroom2 Deluxe controller can only be installed if a Bathroom1 Deluxe controller is installed.
- An additional Kitchen controller cable or Bathroom controller cable can be used if an extension of the cable length is required. It will be necessary to cut an opposite end off both cables to be installed in order to wire them together. Alternatively, the cables may be extended using two-core flex with a minimum cross-sectional area of 0.5 mm<sup>2</sup>.
- Other manufacturers' controllers are not suitable for use and cannot be installed with this water heater.

**⚠ Warning:** Temperature controllers **must not** be fitted to this water heater (874 series) as part of a solar water heater system, water at a temperature much higher than the controller setting can be delivered. If a solar preheater has been installed to an existing water heater installation, then all controllers **must be** disconnected and removed.

**Location – The controllers must be installed in dry, shaded and clean locations.**

**Do not install the controllers:**

- Near a heat source, such as a cook top, stove or oven. Heat, steam and smoke will interfere with the electronic components of the controllers.
- In direct sunlight.
- In or near a wet area. The controllers are not waterproof. Water may damage the controllers.
- Outdoors. The controllers are not weatherproof.

**KITCHEN CONTROLLER**

The standard Kitchen controller (Rheem PN A299853) or Kitchen Deluxe controller (Rheem PN A299861) is to be installed in the kitchen or laundry only. It has a minimum temperature setting of 37°C and a maximum temperature setting of:

- 874 series                      55°C
- 872 series                      55°C

Choose a suitable location for the Kitchen controller, away from water, heat and sunlight.

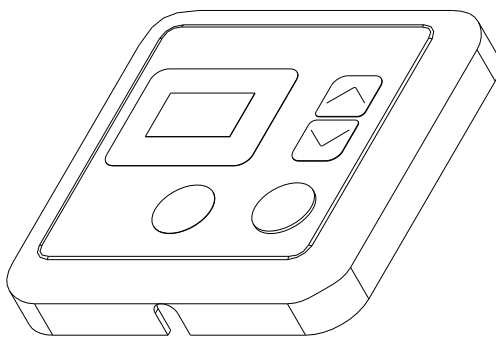

Kitchen controller (standard)

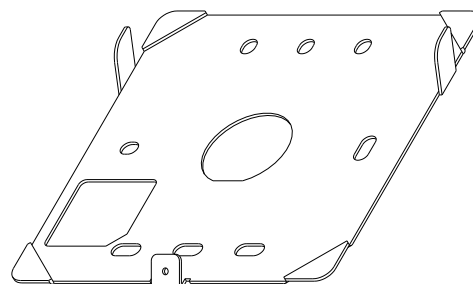

base plate

screw x 2         controller screw

**Kitchen Controller (Standard) Components**

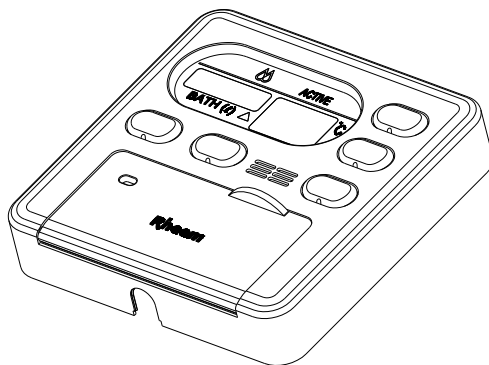

Kitchen Deluxe controller

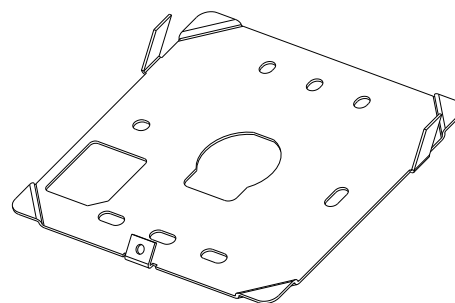

base plate

screw x 2         controller screw

**Kitchen Deluxe Controller Components**

---

**Wiring installation:**

24. Penetrate the wall with a 30-35 mm hole at the controller location.
25. Install the Kitchen controller cable between the location of the controller and the water heater.
26. Remove the base plate from the controller.
27. Draw the cable through the central hole in the base plate.
28. Fix the base plate to the wall using suitable screws and wall anchors.  
Ensure the projections in the base plate are pointing upwards.
29. Connect the cable to the two terminals on the back of the controller (connections are not polarity sensitive).  
Ensure the connecting screws are seated tightly.
30. Place the controller over the base plate.  
Ensure the projections in the base plate fit into the housings in the controller.
31. Fix the controller to the base plate at the bottom of the controller, using the controller screw provided.
32. Proceed to [“Connecting the Controller\(s\) to the Water Heater”](#) on page 66.

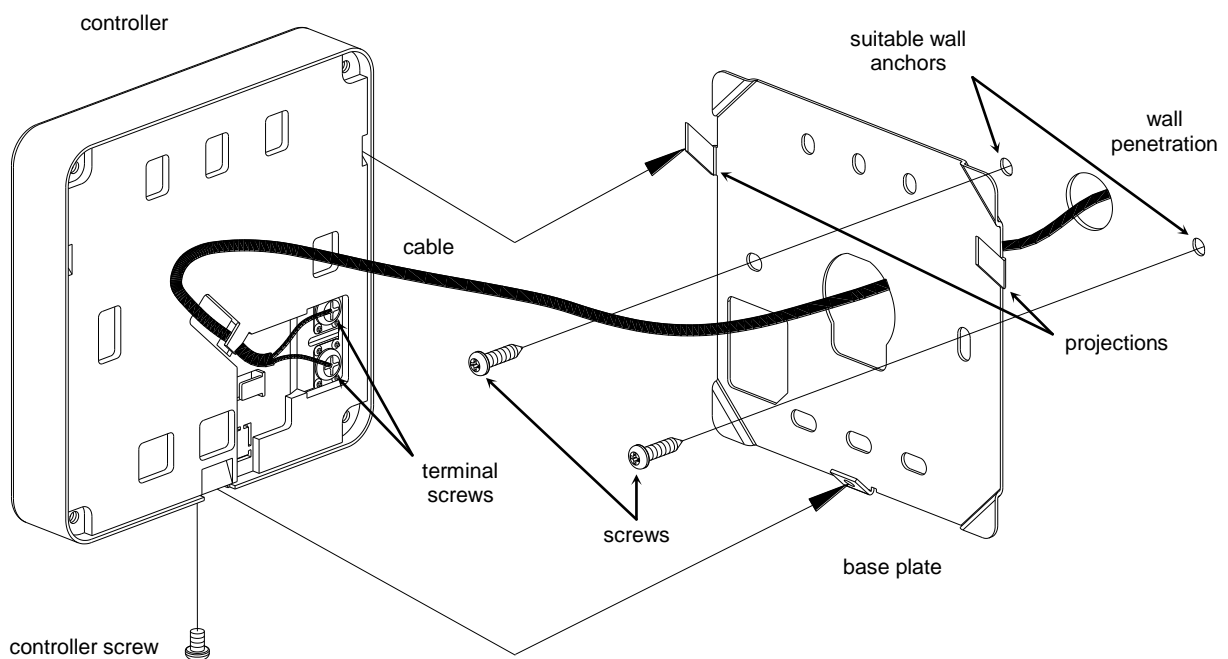

**Kitchen Controller (Standard and Deluxe) Installation  
Concealed Cable**

If it is necessary to have an exposed wiring installation, follow this procedure omitting Steps 24 and 27, and make an opening in the thin section in the underside of the controller to accommodate the cable (as shown in the diagram), prior to Step 29.

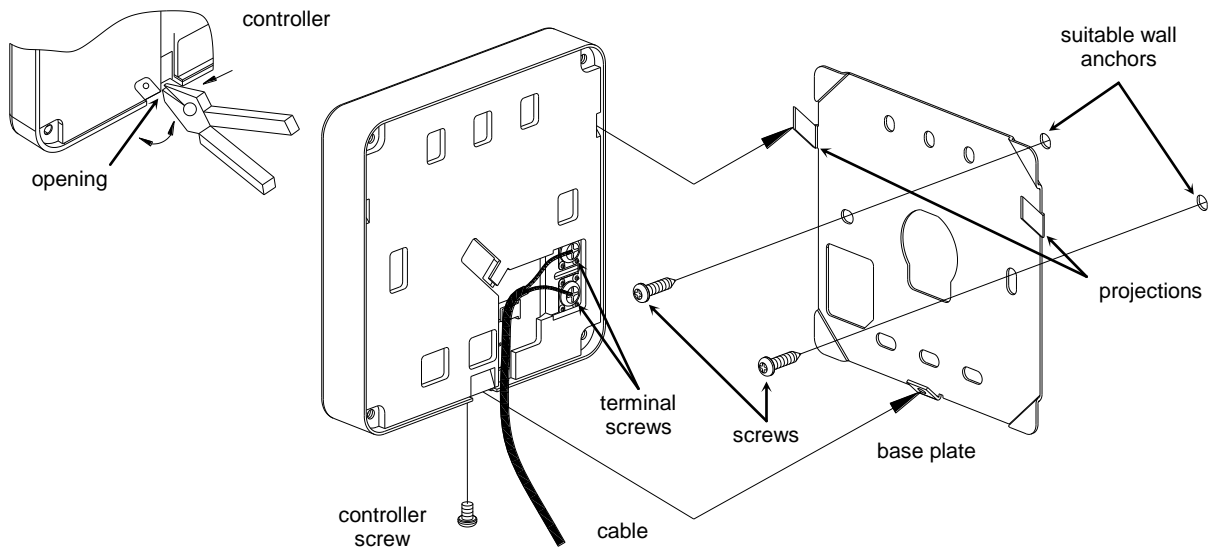

**Kitchen Controller (Standard and Deluxe) Installation  
Exposed Cable**

## BATHROOM1 AND BATHROOM2 CONTROLLERS

If only one Bathroom controller is to be installed, the standard Bathroom1 Controller (Rheem PN A299854) or the Bathroom1 Deluxe controller (Rheem PN A299862) must be used. If two Bathroom controllers are to be installed, one must be a standard Bathroom1 controller and the other must be a standard Bathroom2 controller (Rheem PN A299855) or one must be a Bathroom1 Deluxe controller and the other must be a Bathroom2 Deluxe controller (Rheem PN A299863).

They have a minimum temperature setting of 37°C and a maximum temperature setting of:

- 874 series 50°C
- 872 series 50°C

The method of installation for the standard Bathroom1 and Bathroom2 controllers and the Bathroom1 Deluxe and Bathroom2 Deluxe controllers is identical.

Choose a suitable location for each Bathroom controller, away from water, heat, and sunlight. The Bathroom controllers are supplied with a 250 mm length of wire with connectors to mate with the Bathroom controller cable.

### Notes:

- It is not recommended to have exposed wiring in a bathroom.
- Do not apply sealant to the controller cable.

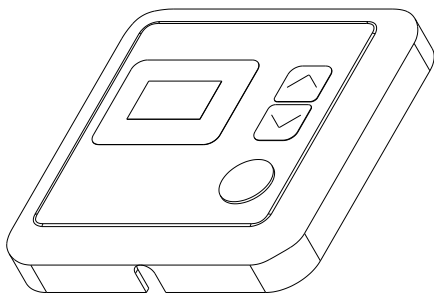

Bathroom controller (standard)

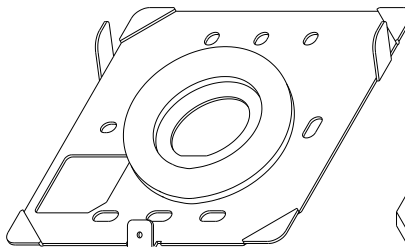

base plate

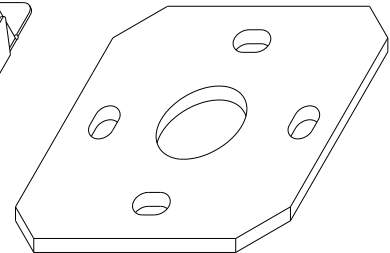

foam packing

screw x 2   controller screw

## Bathroom1 and Bathroom2 Controller Components

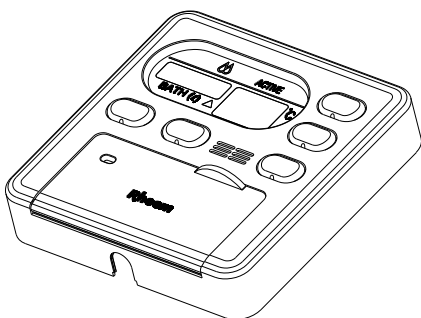

Bathroom Deluxe controller

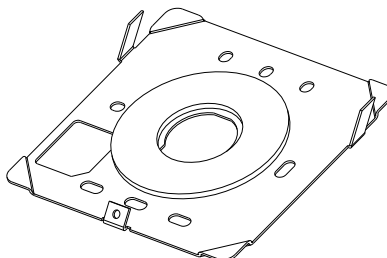

base plate

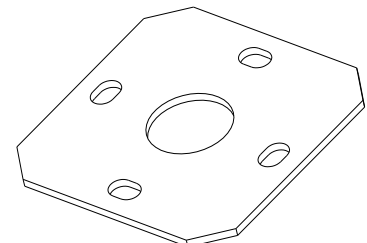

foam packing

screw x 2   controller screw

## Bathroom1 Deluxe and Bathroom2 Deluxe Controller Components



### Wiring installation:

1. Penetrate the wall with a 30-35 mm hole at the controller location.
2. Install the supplied cable between the location of the controller and the water heater.
3. Remove the base plate from the controller.
4. Peel off one side of the adhesive paper from the foam packing and adhere to the back face of the base plate. This is the side without the projections.
5. Peel off the remaining adhesive paper from the foam packing.
6. Draw the cable through the central hole in the base plate.
7. Fix the base plate to the wall using suitable screws and wall anchors.  
Ensure the projections in the base plate are pointing upwards.
8. Plug the controller wire into the Bathroom controller cable.
9. Place the controller over the base plate.  
Ensure the projections in the base plate fit into the housings in the controller.
10. Fix the controller to the base plate at the bottom of the controller, using the screw provided.
11. Proceed to [“Connecting the Controller\(s\) to the Water Heater”](#) on page 66.

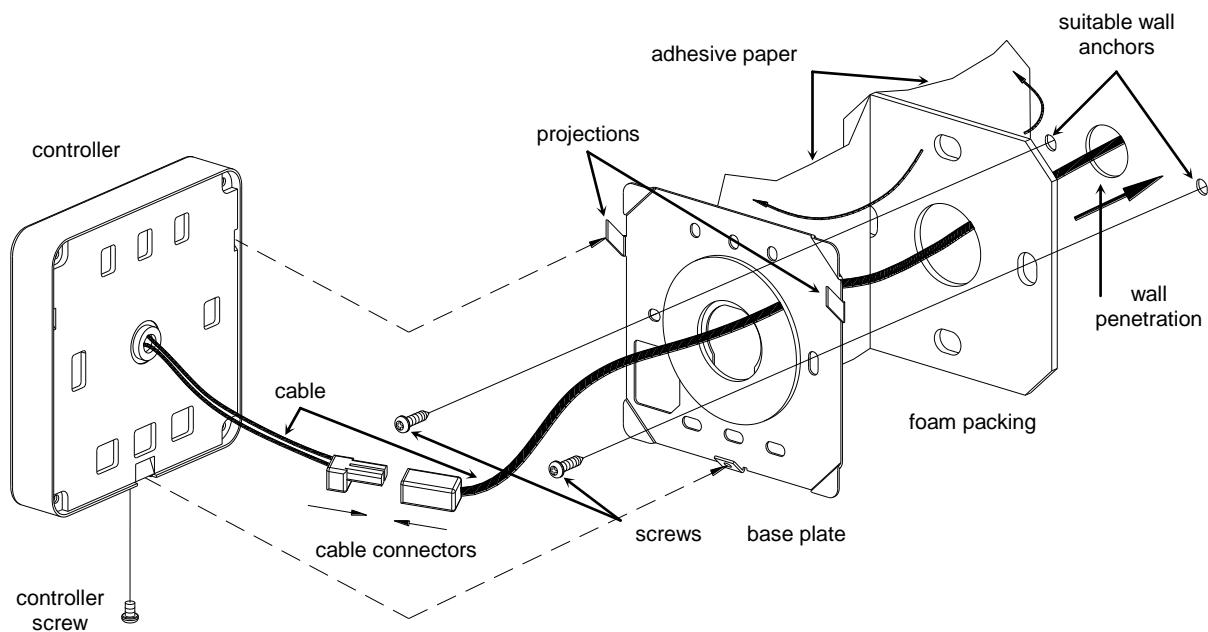

**Bathroom Controller (Standard and Deluxe) Installation**

## CONNECTING THE CONTROLLER(S) TO THE WATER HEATER

To connect the controller(s) to the water heater:

1. Ensure the electrical supply to the water heater is switched off.
2. Unscrew and gently remove the electrical cover from the underside of the water heater.
3. Draw the cable(s) through the electrical cover.
4. Connect a cable lug from each cable to each of the remote controller terminals. Each cable has two cable lugs.

Ensure the terminal screws are seated firmly and there are no excess wire loops inside of the electrical cover.

- The cable connections are non-polarised.
- Three cable lugs, one from each type of controller, can be connected to each remote controller terminal.

5. Place the cable(s) in the cable holder notches.

It is important to seat the cables into the cable notches. Failure to do this may cause an unstable contact or even disconnection of the cables from the terminals if the cables were to be pulled.

6. Refit the electrical cover to the water heater and replace the screws.
7. Switch on the electrical supply to the water heater.

Upon completion of the installation of the controllers, it is necessary to test their operation through the complete range of functions (refer to [“Temperature Control”](#) on pages 9 to 38).

Upon completion and testing of the installation, explain to the householder the functions and operation of the controllers and the water heater.

If it is necessary to turn off the water heater on completion of the installation, such as on a building site or where the premises is vacant, follow the procedure [“To Turn Off the Water Heater”](#) on page 73.

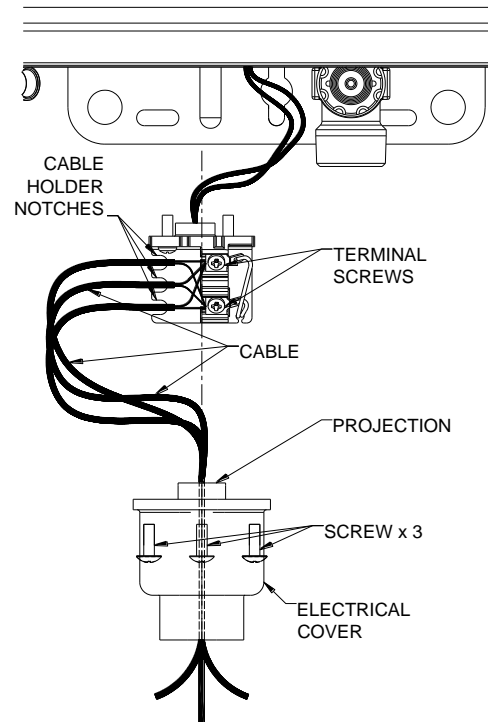

---

## COMMISSIONING

---

All water heaters are tested and adjusted before dispatch from the factory, however further adjustments may become necessary because of local conditions.

### TO TURN ON THE WATER HEATER

- Open all of the hot taps in the house (don't forget the shower).
- Open the cold water isolation valve fully at the inlet to the water heater.  
Air will be forced out of the taps.
- Close each tap as water flows freely from it.
- Check the pipe work for leaks.
- Open the gas isolation valve fully.
- Check the gas pipe work for leaks.
- Plug in the water heater at the power outlet and switch on the electrical supply.
- Turn on a controller, if one is fitted, by pressing the on / off button.  
The light in the on / off button and the priority light (standard controller) or ACTIVE light (Deluxe controller) will both glow.
- Open a hot tap.  
The water heater will operate automatically.
- Check to ensure the flow from each connected hot tap is sufficient to operate the water heater.  
The minimum operating flow rate for all models is 3.0 litres per minute.

The automatic water governor incorporated in the water heater is not adjustable.

To complete the installation, it is necessary to check the gas supply pressure at the inlet to the water heater (refer to "Gas Inlet Pressure" below), the minimum test point pressure and the maximum test point pressure (refer to "Burner Gas Pressure" on page 69).

Upon completion and testing of the installation, ensure the controller(s) is turned off (if fitted). Explain to the householder or a responsible officer the functions and operation of the water heater and the controllers (if fitted).

**⚠ Warning:** Upon completion of the installation and commissioning of the water heater, leave this guide with the householder or a responsible officer. **DO NOT** leave this guide inside of the cover of the water heater, as it may interfere with the safe operation of the water heater or ignite when the water heater is turned on.

### GAS INLET PRESSURE

**IMPORTANT - CHECK** the gas supply pressure at the inlet to the water heater with the water heater and all other gas burning appliances in the premises operating (burners alight). The minimum gas supply pressure is:

Natural Gas	1.13 kPa	LPG	2.75 kPa
-------------	----------	-----	----------

If this minimum cannot be achieved, it may indicate the meter or the gas line to the water heater is undersized. It is important to ensure that an adequate gas supply pressure is available to the water heater when other gas burning appliances, on the same gas supply, are operating.

**Gas Inlet Test Point Pressure**

To check the gas inlet pressure:

1. Close any hot taps and ensure the burners are not operating.
2. Close the gas isolation valve at the gas inlet to the water heater.
3. Locate the gas inlet test point on the gas connection to the water heater.
  - Remove the test point screw and washer from the test point orifice.
  - Connect the manometer.
4. Open the gas isolation valve fully at the gas inlet to the water heater.
5. Observe the gas pressure reading on the manometer.

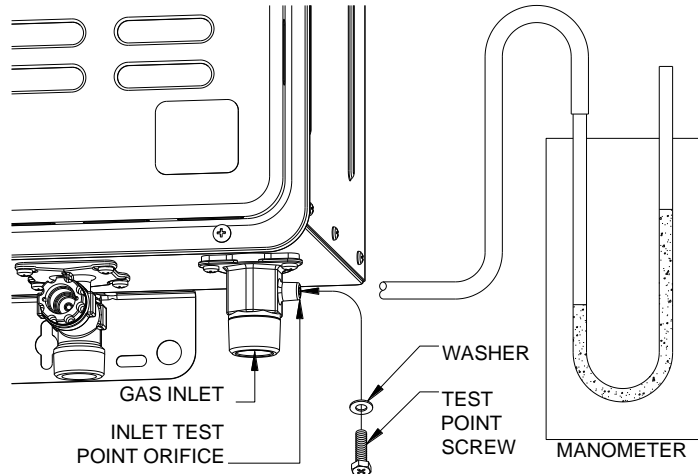

If the manometer reading is between the minimum and maximum inlet gas pressure ratings on the rating label, no adjustment is required.

If the manometer reading is below the minimum inlet gas pressure rating on the rating label, then either the gas pipe to the water heater is undersized and needs to be rectified or adjustment is required at the gas regulator.

If the manometer reading is above the maximum inlet gas pressure ratings on the rating label, then adjustment is required at the gas regulator.

6. Switch on the electrical supply at the power outlet to the water heater if it is not already switched on and turn on a controller, if one is fitted, by pressing the on / off button.
7. Open a hot tap fully and ensure the burners are fully ignited.
 

It may be necessary to open a second tap.
8. Turn on all other gas burning appliances in the house which are on the same gas supply.
9. Observe the gas pressure reading on the manometer.

If the manometer reading is between the minimum and maximum inlet gas pressure ratings on the rating label, no adjustment is required.

If the manometer reading is below the minimum inlet gas pressure rating on the rating label, then either the gas pipe to the water heater is undersized and needs to be rectified or adjustment is required at the gas regulator.

If the manometer reading is above the maximum inlet gas pressure ratings on the rating label, then adjustment is required at the gas regulator.

10. Turn off the other gas burning appliances in the house.
11. If an adjustment was made during Step 9, repeat this procedure from Step 5.
12. Close the hot tap(s).
13. Close the gas isolation valve at the inlet to the water heater.
14. Remove the manometer and refit and tighten the test point screw and washer.
15. Open the gas isolation valve fully at the gas inlet to the water heater.
16. Open a hot tap again so the burners ignite.
17. Test for gas leaks.
18. Close the hot tap.

**BURNER GAS PRESSURE**

It is necessary to check the burner gas pressure at both the minimum and maximum operational settings. To check and if necessary adjust the operational gas pressures, the electrical supply to the water heater must be switched on, the burners ignited and hot water must be flowing from a hot tap.

**⚠ Warning:** The removal of the front panel will expose 240 volt wiring. Take care not to touch wiring terminals.

**Minimum test point gas pressure**

Refer to the rating label on the water heater for the minimum test point gas pressure.

1. Close any hot taps and ensure the burners are not operating.
2. Turn off the controller(s), if one is fitted, by pressing the on / off button and switch off the electrical supply at the power outlet to the water heater.
3. Remove the screws holding the front panel to the jacket.
4. Gently disengage the front panel and pull forward to remove from the water heater.
5. Locate the burner pressure test point on the main burner manifold.
  - Remove the test point screw and washer from the test point orifice.
  - Connect the manometer.
6. Switch on the electrical supply at the power outlet to the water heater and turn on a controller, if one is fitted, by pressing the on / off button.
7. Open the gas isolation valve fully at the gas inlet to the water heater, if not already open.
8. Open a hot tap slowly until the burners ignite.
9. Press and hold down the MIN button and observe the reading on the manometer.
  - “1L” is shown on the LED display.
10. Release the MIN button.

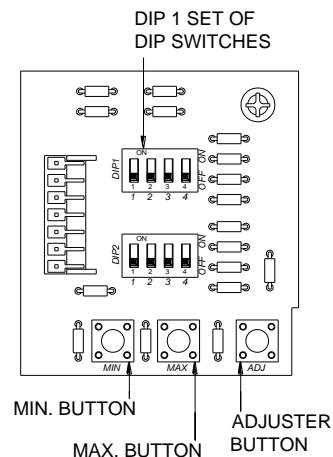
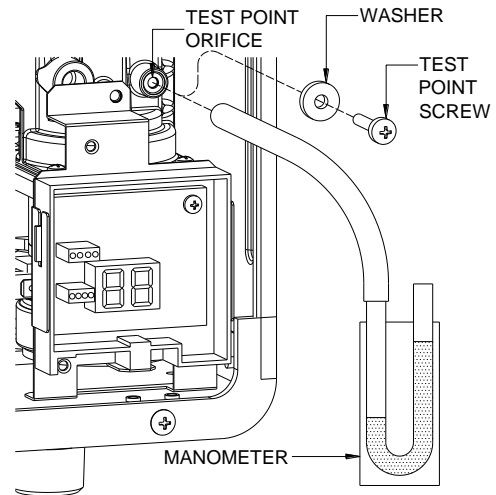

If the manometer reading observed in step 9 agrees with the rating label, no further adjustment is required.

11. To adjust, press and hold the adjuster button.
  - “LH” is shown on the LED display.

**Note:** The adjuster button must be held down continuously through steps 11 to 13.
12. Press and hold the MIN button and observe the reading on the manometer.
  - The manometer reading will change as the test point gas pressure adjusts.

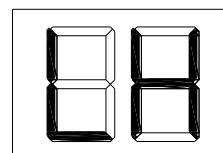
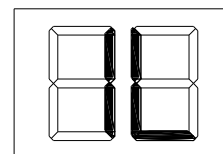

**Note:** While the MIN button is pressed, the gas pressure will at first increase then decrease, cycling between an upper gas pressure limit (39 on the LED display) and a lower gas pressure limit (01 on the LED display).

13. Release the MIN button when the reading on the manometer agrees with the rating label.
14. Release the adjuster button.

**Notes:**

- If the burners extinguish and error code 11 or 12 starts to flash on the LED display:
  - release the MIN and adjuster buttons
  - close the hot tap
  - recommence the procedure from Step 8.
- If the adjuster button is released before Step 13, clear any error code (if displayed) and recommence the procedure from Step 8.

**Maximum test point gas pressure**

Refer to the rating label on the water heater for the maximum test point gas pressure.

Follow Steps 8 to 14 of the “[Minimum test point gas pressure](#)” procedure, but open the hot tap fully and use the MAX button instead of the MIN button. It may be necessary to open two or three hot taps fully, depending upon the model of water heater and the incoming cold water temperature.

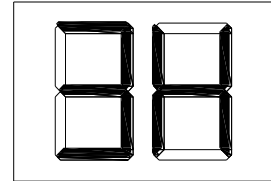

**Note:** In Step 9, “3H” (874627 and 872627 models) will be shown on the LED display.

After setting the minimum and maximum test point gas pressures:

- Close the hot tap.
- Remove the manometer and refit and tighten the test point screw and washer.
- Open a hot tap again so the burners ignite.
- Test for gas leaks.
- Close the hot tap.
- Turn off the controller, if one is fitted, by pressing the on / off button
- Switch off the electrical supply at the power outlet to the water heater
- Refit the front panel and screws to the water heater.

**Clearing Error Code**

If an error code does appear on the LED display during the installation and commissioning process, it will be necessary to clear the error prior in order to complete the installation.

To clear an error code:

- switch off the electrical supply at the power outlet to the water heater
- check the gas isolation valve at the gas inlet to the water heater is fully open
- wait five (5) minutes
- switch on the electrical supply at the power outlet to the water heater

**PRESET OUTLET TEMPERATURE SETTING**

The factory preset outlet temperature setting of the water heater is:

- 874 series 55°C
- 872 series 55°C

If a temperature controller is connected to the water heater, this will override the preset outlet temperature setting and the maximum temperature setting will be:

Model	Maximum Outlet Temperature	
	874 series	872 series
Kitchen controller connected	55°C	55°C
Bathroom controller only connected	50°C	50°C

It is usually not necessary to check or adjust the factory preset outlet temperature setting of the water heater, unless the customer has a particular requirement for this to be done or it is to be installed as a gas booster to a solar water heater.

**Gas Booster for a Solar Water Heater**

Where an 874 series water heater is installed as a gas booster to a solar water heater, the preset outlet temperature setting must be set at 75°C for the system to operate correctly.

It will be necessary to check and if required to adjust the preset outlet temperature setting of the continuous flow water heater when:

- it is installed as a gas booster as part of a solar water heater installation
- it is an existing continuous flow water heater and a solar preheat water heater is then installed.

**Notes:**

- Consideration must be given to the delivery temperature to any ablution and public areas such as a bathroom, ensuite or public amenities. Refer to [“Hot Water Delivery”](#) on page 45 and to [“Schematics of 2 Temperature Zones Using A Temperature Limiting Device”](#) on page 46.

**⚠ WARNING: TEMPERATURE CHANGE MUST ONLY BE MADE BY A QUALIFIED INSTALLER OR RHEEM SERVICE CENTRE REPRESENTATIVE. SEVERE SCALD INJURIES COULD OCCUR IF BATHROOMS AND ENSUITES ARE NOT PROTECTED BY A HOT WATER TEMPERING DEVICE.**

**TO CHECK OR ADJUST THE PRESET OUTLET TEMPERATURE SETTING**

The temperature settings will be displayed on the LED display. The preset outlet temperature settings are:

- 874 series                                38°C, 40°C, 42°C, 43°C, 45°C, 50°C, 55°C, 70°C & 75°C
- 872 series                                38°C, 40°C, 42°C, 43°C, 45°C, 50°C, 55°C, 60°C, 65°C, 70°C, 75°C, & 82°C

It is necessary to have the electrical supply to the water heater switched on during stages of checking or adjusting the preset outlet temperature setting procedure.

**⚠ Warning:** The removal of the front panel will expose 240 volt wiring. Take care not to touch wiring terminals. The adjustment must be carried out by a qualified person.

**⚠ Warning:** This procedure will involve the adjustment of dip switches. Adjustment of a dip switch should only be made with an insulated tool.

To check or adjust the preset outlet temperature setting:

1. Switch off the electrical supply at the power outlet to the water heater.
2. Remove the screws holding the front panel to the jacket.
3. Gently disengage the front panel and pull forward to remove from the water heater.
4. Switch on the electrical supply at the power outlet to the water heater.
5. Switch dip switches 3 and 4 to the on (up) position on the DIP 1 set of DIP switches on the I.C. Board.

The current preset outlet temperature setting will show on the LED display.

If the temperature displayed on the LED display is the desired preset outlet temperature setting, then proceed to step 7, as no further adjustment is necessary.

6. Press the MAX button to increase or the MIN button to decrease the preset outlet temperature setting.

Each press of the MAX or MIN button will increase or decrease the preset temperature by one increment.

The MAX and MIN buttons are located underneath the DIP 1 and DIP 2 set of DIP switches.

**874 series**

If the water heater is to be used as a gas booster to a solar water heater and '55' is shown on the LED display, increase the temperature to 75°C.

The increments are 38°C, 40°C, 42°C, 43°C, 45°C, 50°C, 55°C, 70°C & 75°C.

**872 series**

The increments are 38°C, 40°C, 42°C, 43°C, 45°C, 50°C, 55°C, 60°C, 65°C, 70°C, 75°C & 82°C.

7. Switch dip switches 3 and 4 to the off (down) position.

The LED display will go blank. The preset outlet temperature setting is now set.

8. Switch off the electrical supply at the power outlet to the water heater.
9. Refit the front panel and screws to the water heater.

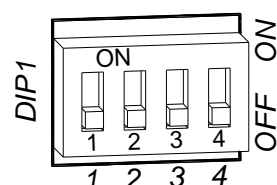
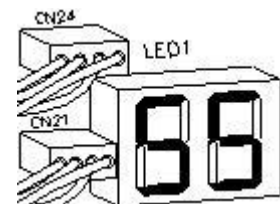
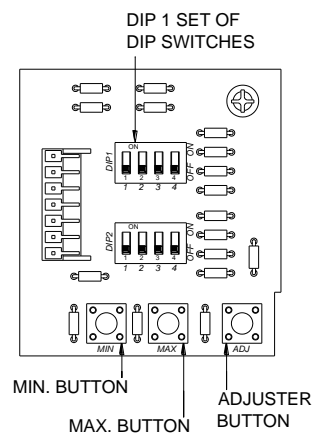
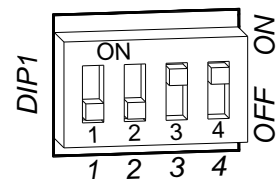



**TO TURN OFF THE WATER HEATER**

If it is necessary to turn off the water heater on completion of the installation, such as on a building site or where the premises are vacant, then:

- Turn off the controller(s) (if fitted) by pressing the on / off button.  
The light in the on / off button will go out and the priority light (standard controller) or the ACTIVE light (Deluxe controller), if it is on, will go out.
- Switch off the electrical supply at the power outlet to the water heater (refer to note below).
- Close the gas isolation valve at the inlet to the water heater
- Close the cold water isolation valve at the inlet to the water heater.
- Drain the water heater if there is a risk of freezing conditions occurring (refer to [“Draining The Water Heater”](#) on page 74).

**Note:** The frost protection system will be rendered inoperable if electrical power is not available at the water heater. Damage caused by freezing due to the unavailability of power at the water heater is not covered by warranty (refer to [“Warranty Exclusions”](#) on page 76). If the power has been switched off to the water heater and there is a risk of freezing, then it is necessary to drain the water heater (refer to [“Draining the Water Heater”](#) on page 74).

---

## DRAINING THE WATER HEATER

---

To drain the water heater:

- Turn off the water heater (refer to “Turn Off The Water Heater” on page 73).
- Open a hot tap (preferably the shower outlet).
- Unscrew the two drain plugs, one each at the cold water inlet and hot water outlet, on the underside of the water heater.

Water will drain from the water heater.

- When water stops flowing from the water heater, close the hot tap.

**Note:** It is recommended not to screw the drain plugs back in, until the water heater is to be turned on again.

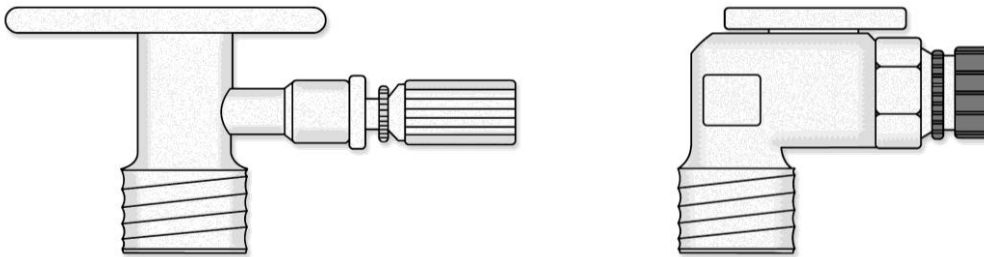

---

## WATER SUPPLIES

---

Your water heater is manufactured to suit the water conditions of most New Zealand Town water supplies. However, there are some known water supplies that can have detrimental effects on the water heater Bore/Rain Water and its operation and / or life expectancy. If you are unsure of your water chemistry, you can obtain information from your local water supply authority.

This water heater is not suitable for connection to bore water or spring water unless a water treatment device is fitted and the pH is within 6.8-7.6. (Refer to Water Quality Page 75)

# RHEEM ELECTRONIC CONTINUOUS FLOW GAS WATER HEATER WARRANTY (NEW ZEALAND ONLY)

## WARRANTY CONDITIONS

Installation	Model	Period	Warranty
<b>All Components (from date of installation)</b>			
Water heater installed in any other than a "single-family domestic dwelling"	All models	Year 1	New component or water heater free of charge, including labour**
Water heater installed in a "single-family domestic dwelling"	All models	Years 1 to 3	New component or water heater free of charge, including labour**
<b>Heat Exchanger (from date of installation)</b>			
Water heater installed in a "single-family domestic dwelling"	All models	Years 4 to 10	New heat exchanger, free of charge, with installation and labour costs being the responsibility of the owner.

**Notes:**

**\*Rheem New Zealand limited is the supplier of Rheem electronic continuous flow gas water heaters, manufactured by Paloma Co., Ltd, a world leader in water heater technology and manufacture.**

**\*\*Refer to item 4 of warranty conditions.**

**Rheem New Zealand reserves the right to transfer fully functional components from the defective water heater to the replacement water heater if required.**

## WATER QUALITY

Your water heater is manufactured to suit the water conditions of most New Zealand metropolitan water supplies. However, there are some known water supplies that can have detrimental effects on the water heater and its operation and / or life expectancy. If you are unsure of your water chemistry, you can obtain information from your local water supply authority plumber or merchant.

This water heater is not suitable for connection to bore, spring or rain water unless a water treatment device is fitted to buffer PH levels to between 6.8 - 7.6.

1. This warranty is applicable only to water heaters manufactured from 1st January 2001.
1. The water heater must be installed in accordance with the Rheem water heater installation instructions, supplied with the water heater, and in accordance with all relevant statutory and local requirements in which the water heater is installed.
2. Where a failed component or water heater is replaced under warranty, the balance of the original warranty period will remain effective. The replaced part or water heater does not carry a new warranty.
3. Where the water heater is installed outside the boundaries of a metropolitan area as defined by Rheem or further than 25 km from a regional Rheem Service Centre, the cost of transport, insurance and travelling costs between the nearest Rheem Service Centre's premises and the installed site shall be the owner's responsibility.
4. Where the water heater is installed in a position that does not allow safe, ready access, the cost of accessing the site safely, including the cost of additional materials handling and / or safety equipment, shall be the owner's responsibility.
5. The warranty only applies to the water heater and original or genuine (company) component replacement parts and therefore does not cover any plumbing or electrical parts supplied by the installer and not an integral part of the water heater, e.g. pressure limiting valve; isolation valves; non-return valves; electrical switches; pumps or fuse.
6. The water heater must be sized to supply the hot water demand in accordance with the guidelines in the Rheem water heater literature.

## WARRANTY EXCLUSIONS

1. REPAIR AND REPLACEMENT WORK WILL BE CARRIED OUT AS SET OUT IN THE RHEEM WATER HEATER WARRANTY, HOWEVER THE FOLLOWING EXCLUSIONS MAY CAUSE THE WATER HEATER WARRANTY TO BECOME VOID AND MAY INCUR A SERVICE CHARGE AND / OR COST OF PARTS.
  - a) Accidental damage to the water heater or any component, including: Acts of God; failure due to misuse; incorrect installation; attempts to repair the water heater other than by a Rheem Service Centre or the Rheem Service Department.
  - b) Where it is found there is nothing wrong with the water heater; where the complaint is related to excessive discharge from the temperature and / or pressure relief valve due to high water pressure; where there is no flow of hot water due to faulty plumbing; where water leaks are related to plumbing and not the water heater or water heater components; where there is a failure of gas, electricity or water supplies; where the supply of gas, electricity or water does not comply with relevant codes or acts.
  - c) Where the water heater or water heater component has failed directly or indirectly as a result of: excessive water pressure; excessive temperature and / or thermal input; corrosive atmosphere; ice formation in the pipe work to or from the water heater; ice formation in the waterways of a water heater without a frost protection system; ice formation in the water heater with a frost protection system where the waterways of a electricity supply has been switched off or has failed and the water heater has not been drained in accordance with the instructions; ice formation in the waterways of a water heater with a frost protection system due to an ambient temperature below -20°C (including wind chill factor); ice formation in the water ways of a water heater where the water heater has not been installed in accordance with the Rheem water heater installation instructions.
  - d) Where the water heater is located in a position that does not comply with the Rheem water heater installation instructions or relevant statutory requirements, causing the need for major dismantling or removal of cupboards, doors or walls, or use of special equipment to bring the water heater to floor or ground level or to a serviceable position.
  - e) Repair and / or replacement of the water heater due to scale formation in the waterways or the effects of corrosive water when the water heater has been connected to a scaling or corrosive water supply as outlined in the Owner's Guide and Installation Instructions booklet.
2. SUBJECT TO ANY STATUTORY PROVISIONS TO THE CONTRARY, THIS WARRANTY EXCLUDES ANY AND ALL CLAIMS FOR DAMAGE TO FURNITURE, CARPETS, WALLS, FOUNDATIONS OR ANY OTHER CONSEQUENTIAL LOSS EITHER DIRECTLY OR INDIRECTLY DUE TO LEAKAGE FROM THE WATER HEATER, OR DUE TO LEAKAGE FROM FITTINGS AND/OR PIPE WORK OF METAL, PLASTIC OR OTHER MATERIALS CAUSED BY WATER TEMPERATURE, WORKMANSHIP OR OTHER MODES OF FAILURE.