

Cabinet Specification

Mini B



MB 400



MB 550



MB 800

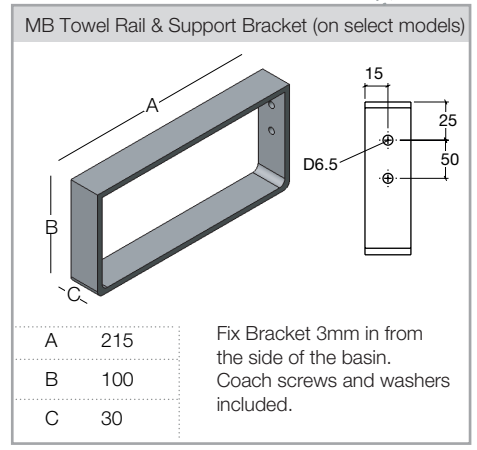
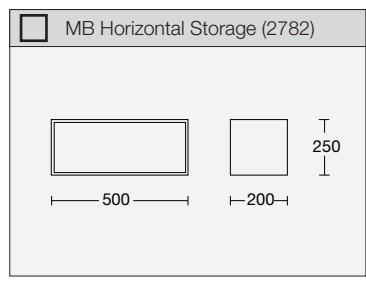
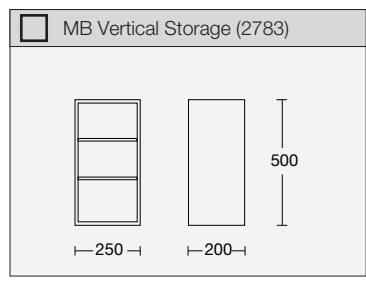
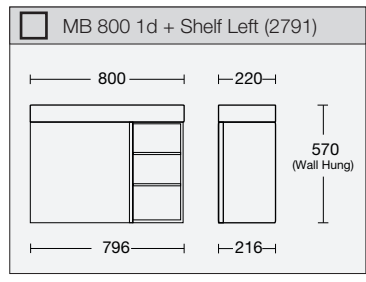
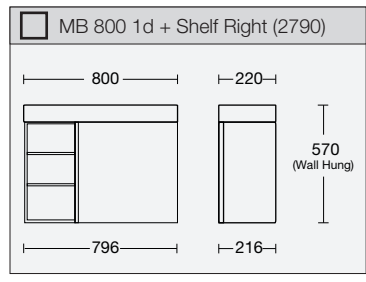
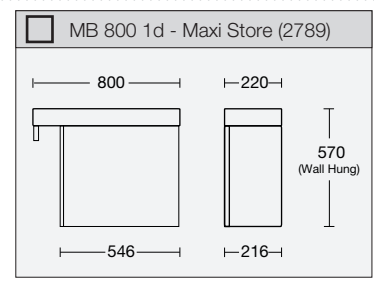
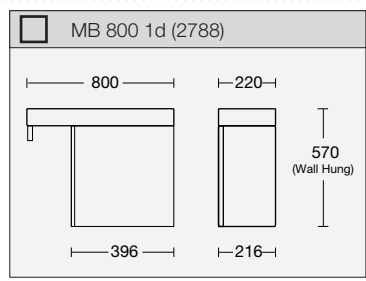
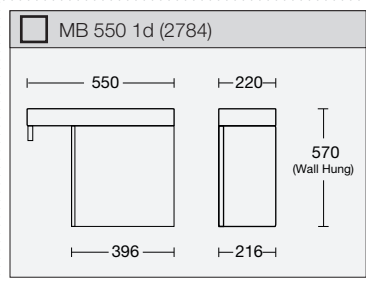
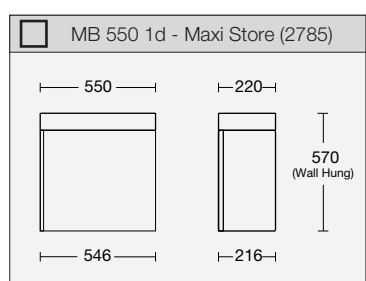
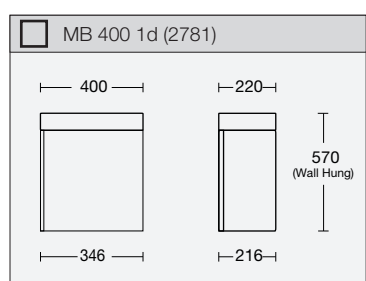

Revised: 05/2016