

Installation & User Guide

Dual-Flush Toilet

ModernLife BTW / Veil BTW / Harken NBTW Illustrations

KOHLER®

1378782-A2-A

Tools and Materials

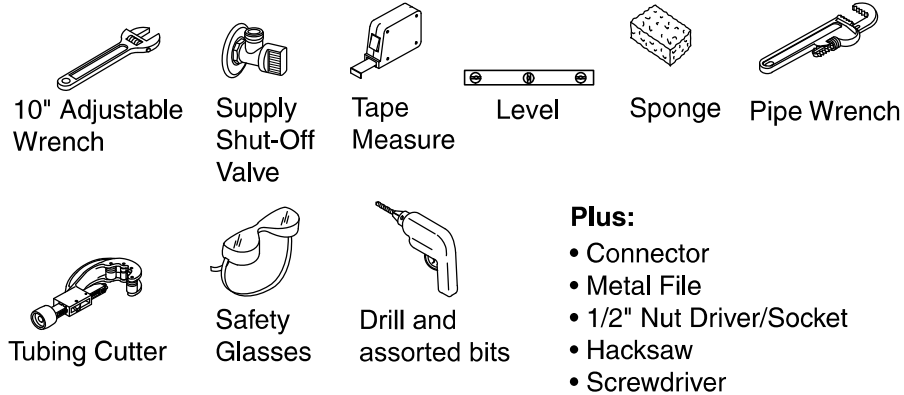

Thank You For Choosing Kohler Company

We appreciate your commitment to Kohler quality. Please take a few minutes to review this manual before you start installation. If you encounter any installation or performance problems, please don't hesitate to contact us. Our phone numbers are listed on the back cover. Thanks again for choosing Kohler Company.

Before You Begin



CAUTION: Risk of personal injury or product damage. Handle with care. Vitreous china can break or chip if the product is handled carelessly.

- Observe all local plumbing and building codes.
- Carefully inspect the new toilet for damage.
- If the existing toilet does not have a supply shut-off valve below the cistern, install one before installing the new toilet.
- Install sufficient backing behind the finished wall to provide a secure material for the anchoring devices.

IMPORTANT NOTICE TO INSTALLERS!:

NOTE: The toilet pictured in the installation steps may differ from the model being installed.

Pan Installation

1 Remove the existing toilet: Turn off the water supply and flush the toilet, then sponge out all remaining water from the cistern. Disconnect the supply shut-off valve (if present), and remove the old pan and cistern.

CAUTION: Risk of hazardous gases. If the new toilet is not installed immediately, temporarily stuff a rag in the closet flange. Ensure this is removed before installing the new toilet

2 Define the position of connector: Place the connector onto the pan, position between outlet and waste pipe.

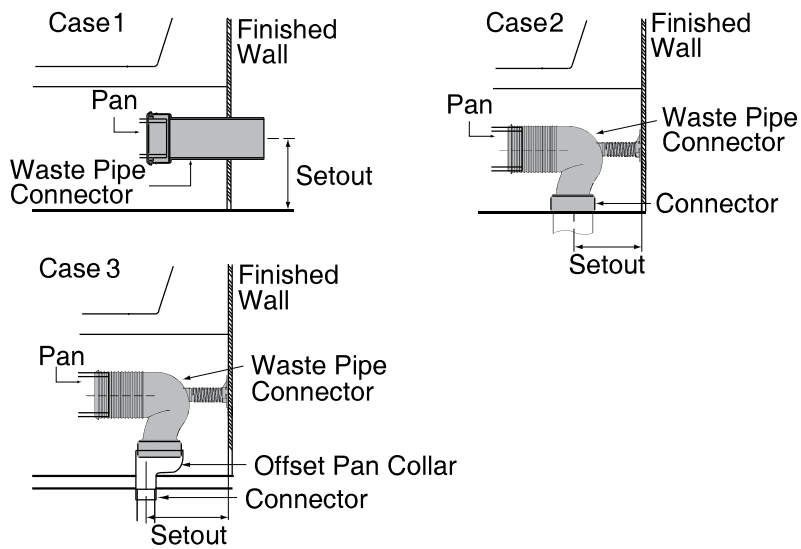

3 Mark the positions of the floor fixing kit holes. Use the template (if supplied)

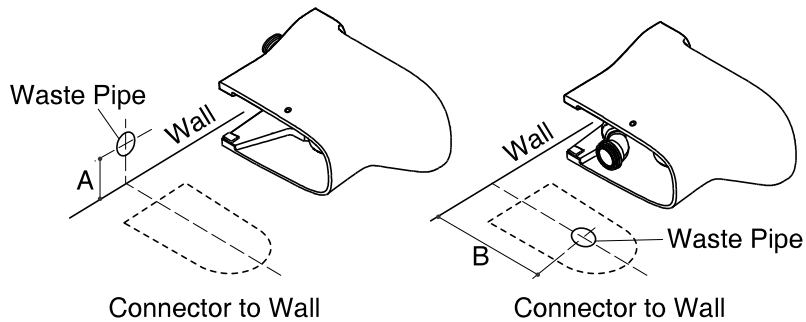

4 Floor fixing - 2 methods

4.1 With Bracket

Drill 10 mm fixing holes at the marked locations on the floor and insert the anchor. Place a washer onto each of the hexagon screws and insert them in the brackets. Fix the brackets to the floor. Position the toilet in the marked position. install the sleeves using screws fix the toilet to the brackets. Attach the caps to the screw heads.

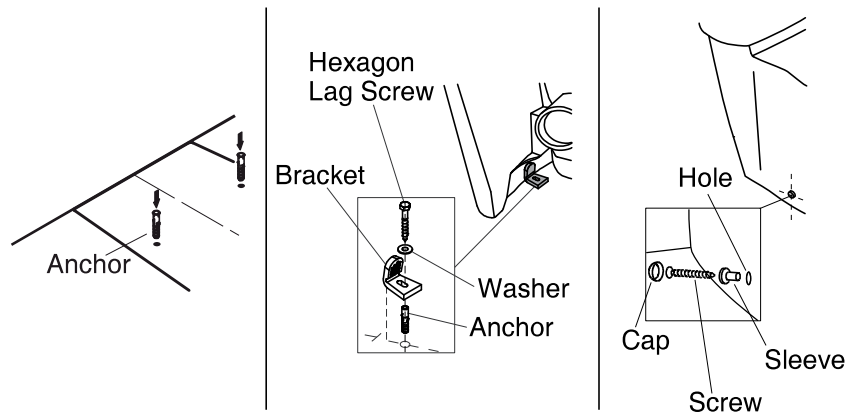

4.2 With Screw Only

Place the toilet into the desired position. place the protective plastic sleeve onto the drill bit and, using the anchoring holes in the toilet as your guide, drill 8 mm fixing holes in the floor. place the anchors into the fixing holes through the toilet. Using the screws fix the toilet to the floor. attach the caps to the screw heads.

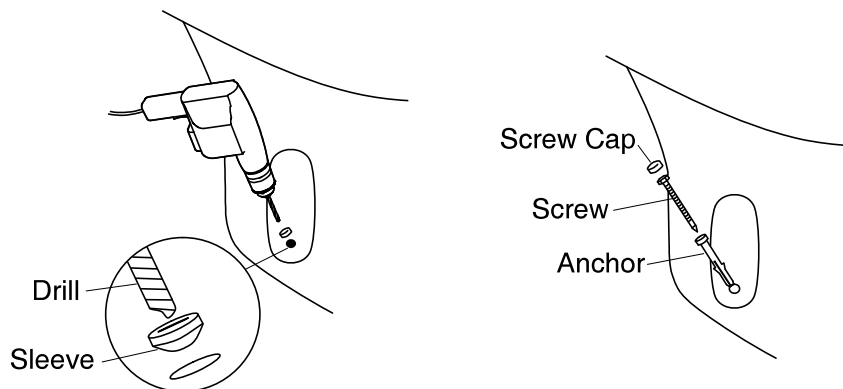

Cistern Installation

1 Cistern information.

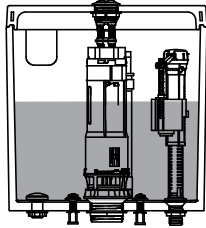

Type A
Optional bottom inlet valve
(Not supplied)

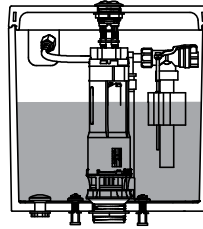

Type B

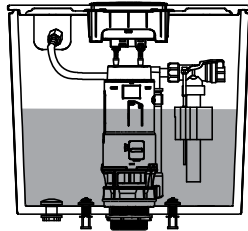

Type C

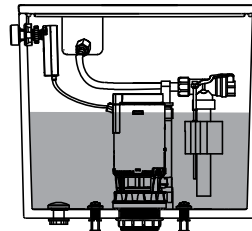

Type D

2 Position the cistern on the pan by centering the gasket on the pan inlet. Assemble the retaining and sealing washer to the screw. Securely tighten the screw so the cistern is level.

* Optional for different product

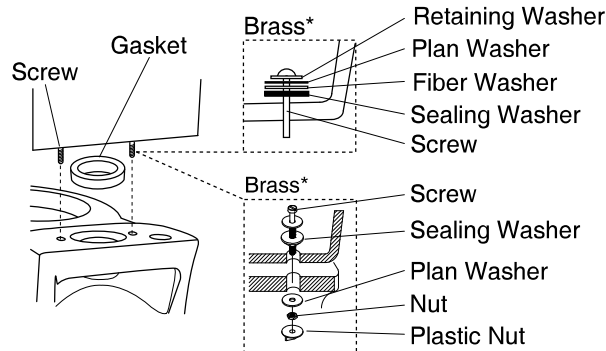

3 Connect the supply shut-off valve to the supply hose and connect supply hose to toilet supply shank.

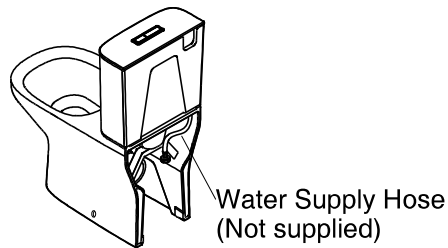

Bottom Inlet Type

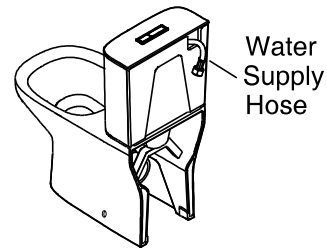

Rear Inlet Type

Seat Installation

1 Install the seat as per the supplied seat instructions.

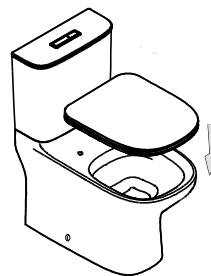

Push Button Installation

Type A

1 Disassemble the push rods.

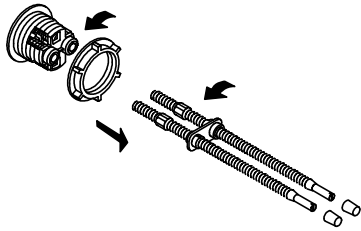

2 Using the push rod, measure the distance between the flush valve and the top of the cistern lid. Mark this length and cut the push rod to length.

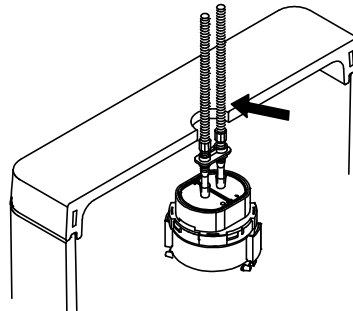

3 Reassemble the push rods.

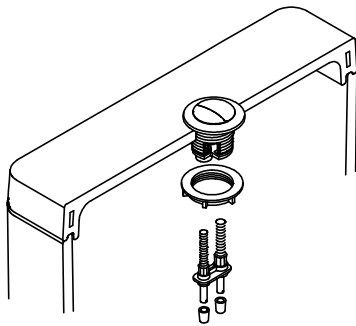

4 Fit the lid and test the buttons. Adjust the rods as required.

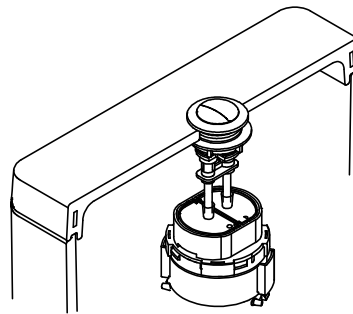

Push Button Installation

Type B

- 1** Remove the rods from push button.

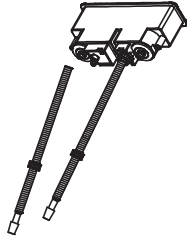

- 2** Record the height of rods. (X = measure from the top of flush valve body to rim mouth of push button hole)

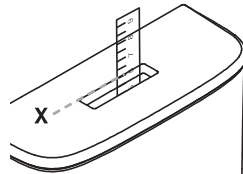

- 3** Calculate the height of rods by the record height of rods minus 55 mm. Cut excess of rods.

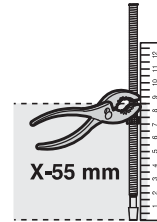

- 4** Rest the end of rods 10 mm.

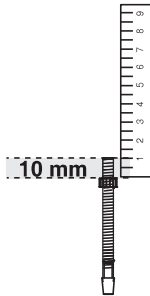

- 5** Screw the rods into the rod holes.

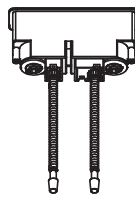

- 6** Install the push button into the push button hole.

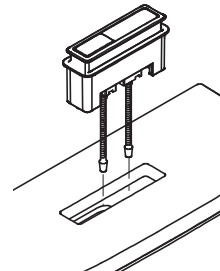

- 7** Assemble the sleeve and tighten with screws.

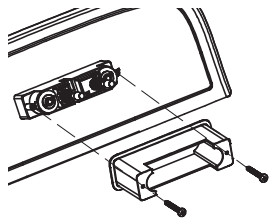

- 8** Install the tank cover.

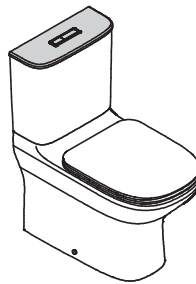

- 9** Press the push buttons for testing.

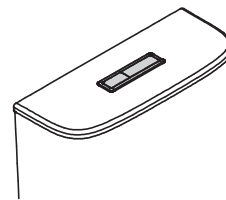

Flush Valve Removal and Installation

Flush Valve A

1 Release flush valve by turning right and pull straight up on the canister.

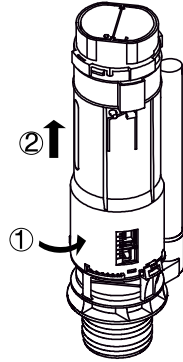

2 Assembly flush valve by pushing straight down into the canister and turning left.

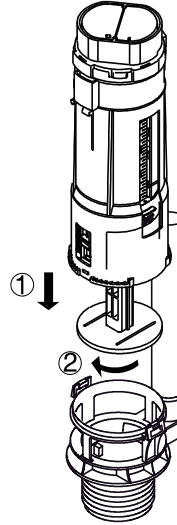

Flush Valve B

1 Release flush valve by squeezing the tabs on both side of the canister and pulling straight up out of the flush valve.

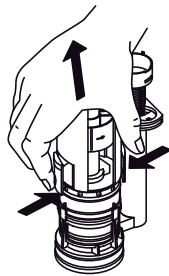

2 Assembly flush valve by pressing it into the flush valve so it snaps into place.

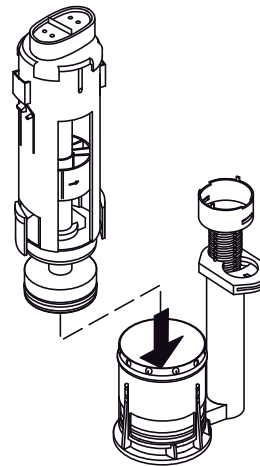

CONTACT AND WARRANTY INFORMATION

For warranty information, please visit our website

Australia

www.au.kohler.com.

New Zealand

www.kohler.co.nz

KOHLER®
CALL US FOR HELP

NEW ZEALAND
KOHLER NZ LTD

Free Ph: 0800 564 537 (0800 KOHLER)
Free Fax: 0800 664 488
www.kohler.co.nz

AUSTRALIA
KOHLER CO.

Free Ph: 1 800 KOHLER
(1 800 564 537)
www.au.kohler.com