



Puretec[®]
PERFECTING WATER

⚠ CAUTION

**DO NOT OVERTIGHTEN.
DO NOT USE
LIQUID SEALANTS.**



**SURGE PROTECTION
REQUIRED /
NO EXTENSION CORDS.**

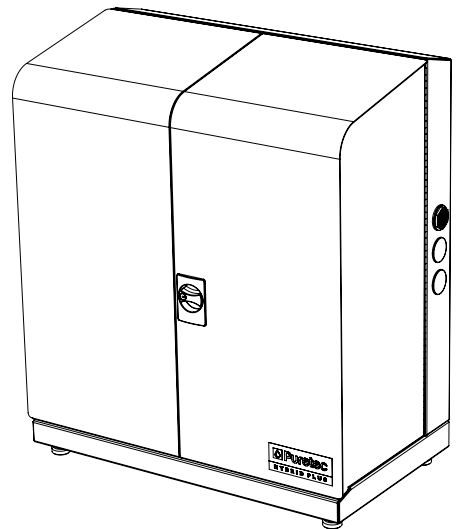

User Guide

HybridPlus™ Series

Complete Household Water Filtration & Pressure System



WaterMark

WMTS103:2016

Certificate No. WM 74593

Australian Certification
Services

NOV2021

For correct operation & installation, it is essential to observe these instructions.

What's Inside

Puretec Customer Service	3
Introduction.....	3
Preparing Your System	4
Positioning Your System	5
Power Surge Protection.....	5
Installation Requirements.....	6
Initial Installation Procedure.....	8
UV Lamp Diagram.....	15
Operation.....	16
Radfire UV Unit.....	16
Lamp Ballast Operation	16
Lamp Ballast Specifications.....	16
Replacement Parts Guide	17
Cartridge Replacement Procedure.....	18
Lamp Replacement Procedure	19
Quartz Sleeve Maintenance/Replacement Procedure.....	20
Troubleshooting Guide	23
Warranty.....	25

Product Information	
Distributor:	
Installer:	
Phone:	
Date Installed:	

Puretec Customer Service

Thank you for purchasing a Puretec HybridPlus Series Complete Household Water Filtration & Pressure System. Your system is a proven performer manufactured from quality materials and components and will give years of 'spring like' water, free of impurities, if maintained and installed properly (refer installation requirements p.6).

HybridPlus P3, P6, P9 & P12 models include a Grundfos pump and are covered by Grundfos for the warranty as stated in the Grundfos user guide. For assistance please call the Puretec Customer Service Helpline on 1300 140 140 (Australia) or 0800 130 140 (New Zealand).

Puretec Hybrid UV systems are designed for common rainwater. The effectiveness of a UV system is dependent on the clarity of water present. If you are unsure of the clarity of your water Puretec can arrange a UVT test to verify that no further filtration is required before the UV. Contact Puretec on 1300 140 140 (AU) or 0800 130 140 (NZ) for further information on this.

Introduction

Puretec's HybridPlus Series is specifically designed to kill harmful bacteria in untreated water supplies and to deliver stable water flow on demand to every tap/outlet in the house. It uses a natural purification process that's eco-friendly and chemical-free. It includes pre-filtration to ensure that particulate matter does not shield micro-organisms from the UV light.

This system will effectively treat water, depending on the required UV dosage and existing water quality.

The HybridPlus systems are suitable for tank only, mains water back-up, bore water and surface water treatment (subject to water quality) but can be used in other situations. For other types of water supply please contact your local Puretec stockist or call our Puretec Customer Service Helpline on 1300 140 140 (Australia) or 0800 130 140 (New Zealand).

The Puretec HybridPlus system cartridges and lamp need replacing regularly to maintain optimum performance. This is a simple procedure when following instructions. For replacements contact your nearest Puretec stockist. Cartridges should be replaced every 6 - 12 months, dependant on water quality and lamps replaced annually.

Your new Hybrid system incorporates a failure warning feature that warns you of a lamp failure by:

1. An LED warning light
2. An audible alarm

In addition, when the alarm "beeps" on and off, the lamp is due to be changed so effective treatment is maintained. A Green LED indicates that the system is operating correctly.

Preparing Your System

Puretec systems are designed to run economically for many years, dependent on the initial installation and periodical maintenance.

Please read all instructions carefully as failures caused by incorrect installation or operation are not covered by warranty.

On removing your Hybrid system from its carton you should check all the components (especially the lamp), to ensure all are present and have not been damaged in transportation. Depending on your model, you should have:

1. HybridPlus System
2. UV Lamp (in cardboard tube)
3. Bag containing Spanner, User Guide, Spring and Surge Protector



HYBRIDPLUS SYSTEM



+ EXTRA HOSES X 2 (ONLY SUPPLIED WITH P1 MODELS)

Remove all the packing materials prior to use.

As a responsible manufacturer we care about the environment. We urge you to follow the correct disposal procedure for your product and packaging materials. You must dispose of this product and its packaging according to local laws and regulations.

Positioning Your System

Choose a location with a structurally appropriate position. Allow a chamber length space above the unit for removal of the lamp and sleeve from the Radfire UV system during servicing and allowance for the swing doors to open (see Fig. 5).

To protect your HybridPlus system make sure the site is frost free and has adequate ventilation. Choose a location with adequate drainage and where water spillage will not cause damage that may occur over time from leaking pipe joints or seals.

Power Surge Protection

An electrical power surge or spike can travel on the supply lines and cause serious damage to your electrical equipment. The Radfire UV Electronic ballast has a fuse (non-replaceable) to protect the circuit. The fuse is not a lightning arrester and may not protect the Radfire if lightning or a very powerful surge hits the unit.

A suitable surge protection device has been provided with this product. Puretec recommends the use of a surge protector (the one supplied or otherwise) or warranty may be voided.

WARNING: The Arlec power surge protector that is provided is not weatherproof & MUST be protected from water/moisture.

It would usually be sufficient for the surge protector to be installed under the eaves of a house and/or out of the weather, otherwise, it would need to be suitably protected. Ensuring the surge protector is suitably protected from water/moisture is the responsibility of the user. Alternatively a hard-wired outdoor surge protector may be installed by a qualified electrician or an outdoor rated surge protector may also be used.

Re-order code for surge protectors: PC-SURGE

Do not use long extension leads as they may cause substantial voltage drop and/or poor lamp performance.

We recommend the use of an RCD or earth leakage circuit breaker on the power supply to your unit.

Installation Requirements

- Puretec HybridPlus systems should be protected from harsh environments where overexposure to salt or aggressive chemicals can occur.
- Cold water line only.
- Power supply: AC 240V | 50Hz
- Min/Max pressure: 300 - 875 kPa. If pressure exceeds max pressure, an approved pressure limiting device needs to be fitted. If water hammer is present, fit a hammer arrestor close to the source of the hammer. **Note:** Check local plumbing regulations as a specific kPa limit for the pressure limiting valve may be required, in most case limit is 500 kPa.

Note: For point of entry installations an approved dual check backflow prevention device must be installed.

- Supply temperature 0 - 52 °C (protect from freezing).
- Alternative fittings may be required if being connected to anything other than 25 mm threads.

Note: Only use thread seal tape. Do not use liquid sealant.

- Ensure the water supply flow rate does not exceed the rated maximum flow rate of the HybridPlus system.
- Ensure the electrical power supply to the HybridPlus system is sufficient, allowing for other appliances that may be connected to the circuit e.g. pump, and ensuring it is surge protected, and protected against brown-outs. If in doubt, please consult a qualified electrician.
- Use unions at pipe connections to enable easy removal and servicing. Use sufficient tape to ensure airtight seal and do not over tighten. To prevent strain on the unit always support heavy inlet and outlet pipes.
- Where the water being treated contains unusually high levels of dissolved solids particularly hard water, iron, manganese or biological organisms, a deposit build up on the quartz sleeve may occur over time. Maximum recommended parameters are as follows:

Iron:	less than 0.3 mg/L
Hydrogen Sulfide:	less than 0.05 mg/L
Suspended Solids:	less than 10mg/L
Manganese:	less than 0.05 mg/L
Hardness:	less than 110mg/L

Application warning: minimum water characteristics must be met before installation of Radfire™ to ensure proper operation and continuous protection.

- If stated water quality parameters are exceeded; pre-filtration is required as water of this quality can compromise the effectiveness of the UV system. The filters and the sleeve should be cleaned or replaced as required to keep them in good condition.
- If bacteria has been present prior to the installation of this system, we recommend flushing the pipelines with Puretec TankSafe.
- The system should not be used for any other purpose without specific referral to Puretec.
- Supply line diameter 25mm or larger.
- Heating of water is an integral feature associated with UV systems and if this is deemed a problem we recommend installing a temperature management valve, which is installed inline immediately after the system and releases water periodically. Ordering code is **RI-TMS4**.

Note: This water filtering appliance should only be installed by a fully qualified & licenced plumber.

Installation Note: A water filter system/tap, like any product, has a limited lifespan and if not replaced, will eventually fail. Failure can happen early due to unforeseen circumstances. To avoid possible property damage, this product should be regularly examined for leakage and/or deterioration and replaced when necessary. We strongly recommend that a drain pan, plumbed to an appropriate drain or outfitted with a leak detector, be used in those applications where any leakage could cause property damage. We also strongly recommend that the water supply be turned off, upstream to the water filter system/tap, if no one is home for an extended period of time.

**INSTALLATION SHOULD BE COMPLETED BY QUALIFIED TRADESPEOPLE.
FAULTY OPERATION DUE TO UNQUALIFIED PERSONS WILL RESULT IN VOIDED
WARRANTY COVERAGE.**

Initial Installation Procedure

The Puretec HybridPlus Series has 1" [25mm] plumbing connections. It can be configured so the water inlet/outlets and the power cord can be installed on the left or right of the unit. This allows extra flexibility for a variety of installations. The unit comes with the water inlet connections on the left and the outlets on the right side of the unit.

Fig 1. As Supplied Outlet/Inlet Connections P9 & P12 Models

As standard the HybridPlus P9 & P12 systems come as shown below.

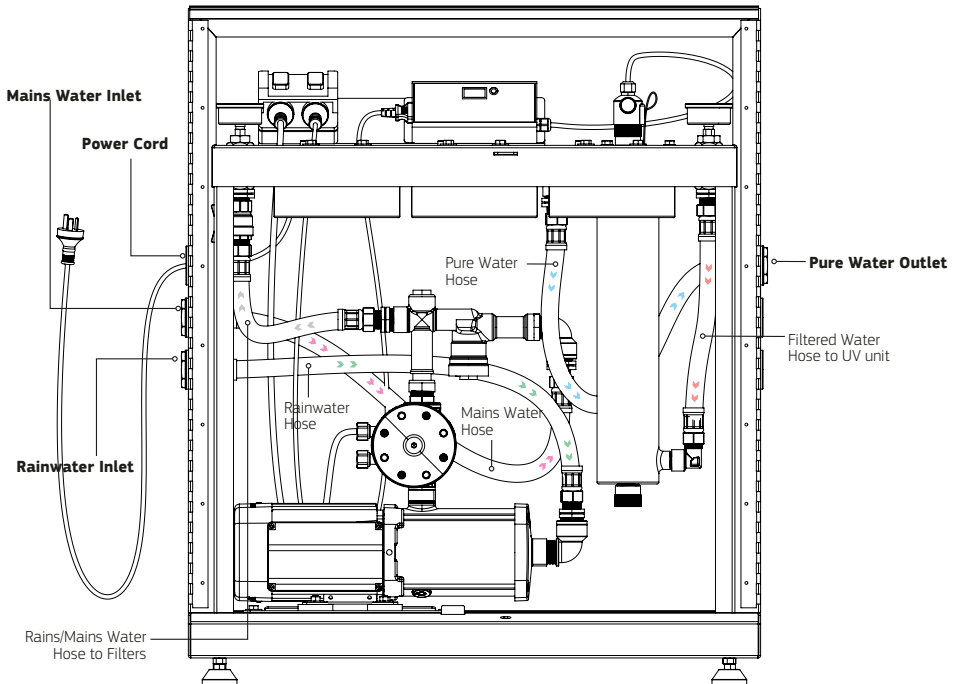

Fig 2. Alternative Outlet/Inlet Connections Example P9 & P12 Models

To change the connection configuration unscrew the coupling nut on the outside of the cabinet and redirect the hose and the coupling to the side/connection desired. You will need to remove the rubber plug from the selected connection port to insert the coupling and fasten the coupling nut to secure the fitting.

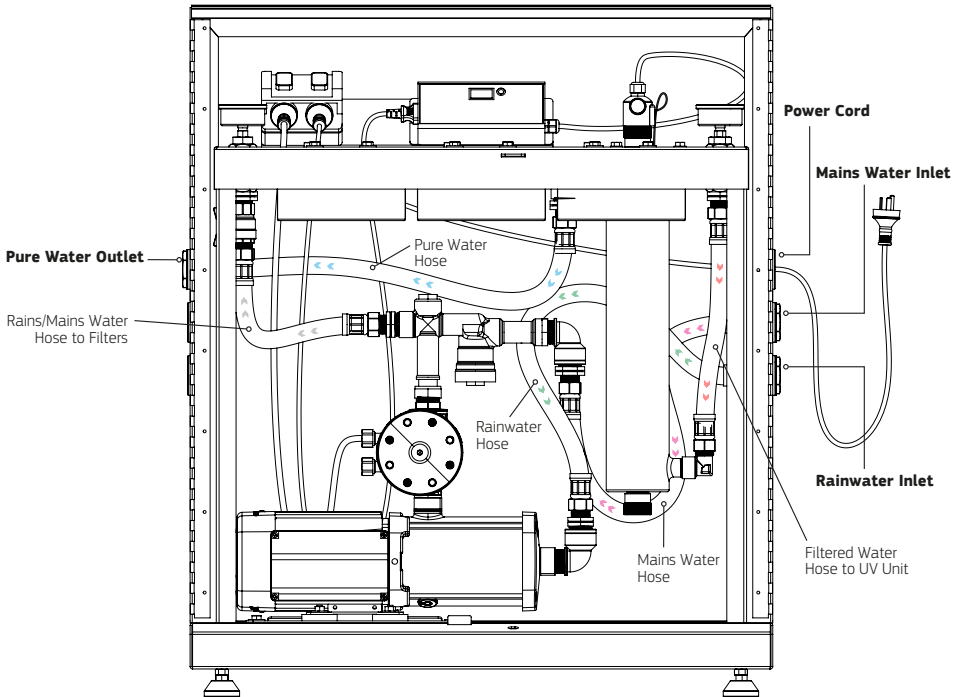

Fig 3. How To Use Couplings

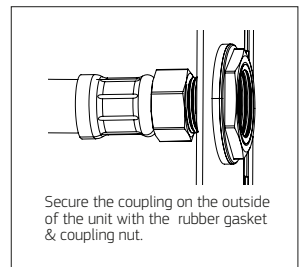
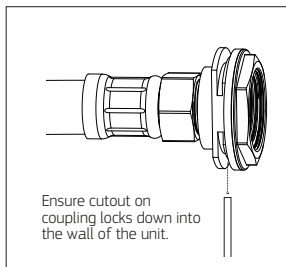
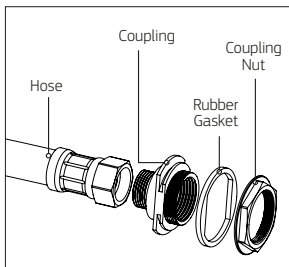

Fig 4. As Supplied Plumbing Connections - P3 & P6 Models

The HybridPlus P3 & P6 systems come supplied as shown below and are designed to be used for dedicated rainwater supplies. The inlet and outlet of the rainwater supply and the power cord can be switched to different sides of the unit as shown in Fig 2.

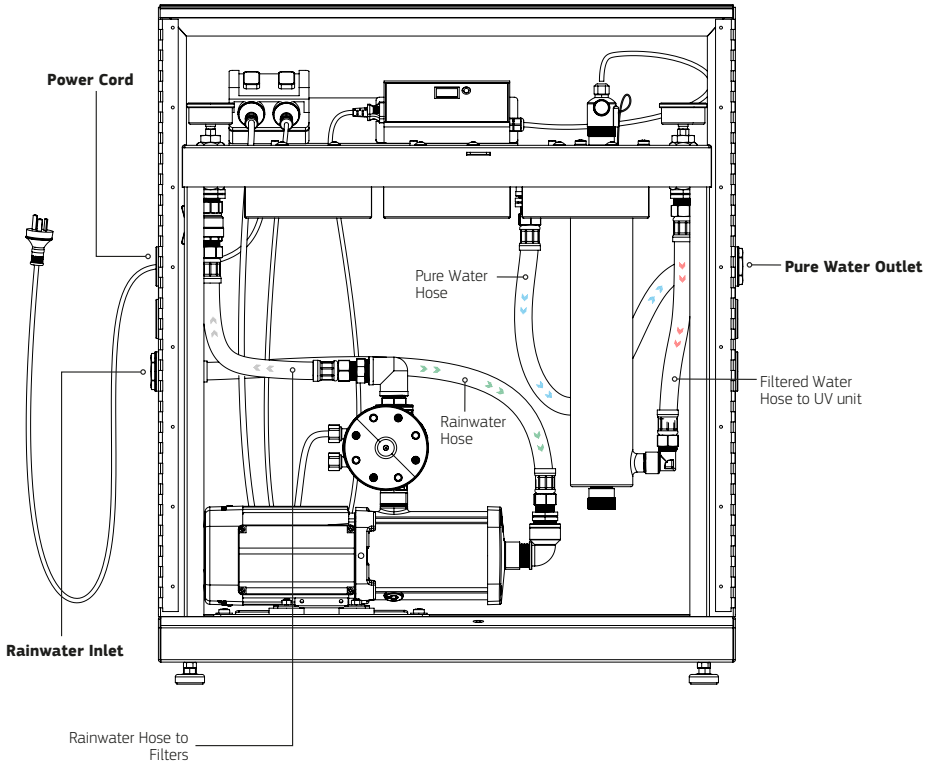

Fig 5. As Supplied Plumbing Connections - P1 Models

The HybridPlus P1 system comes supplied as shown below. The unit comes with the water inlet connections on the left and the outlets on the right side of the unit but can be reconfigured to suit as per Fig 2.

Note: This model does not include a pump or switchover valve but has the allowance to install your own pressure system into the unit. Max pump dimensions: 560 (H) x 540 (W) x 240 (D) mm.

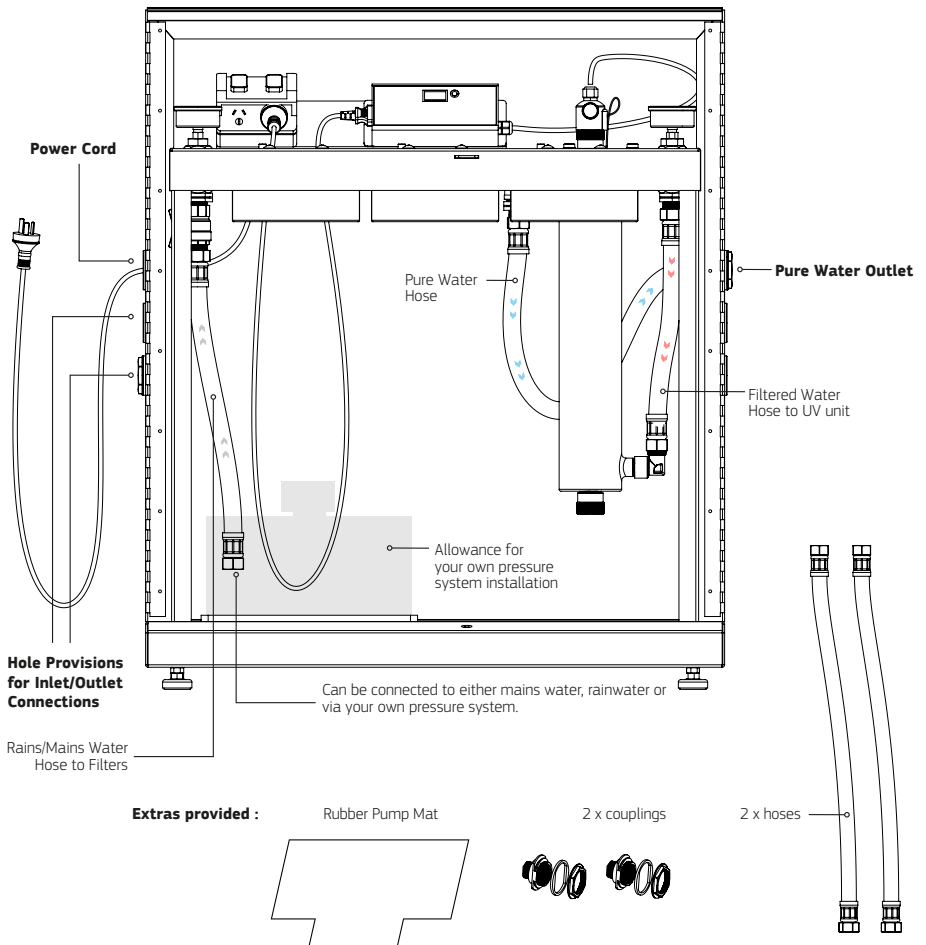
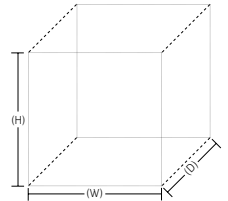
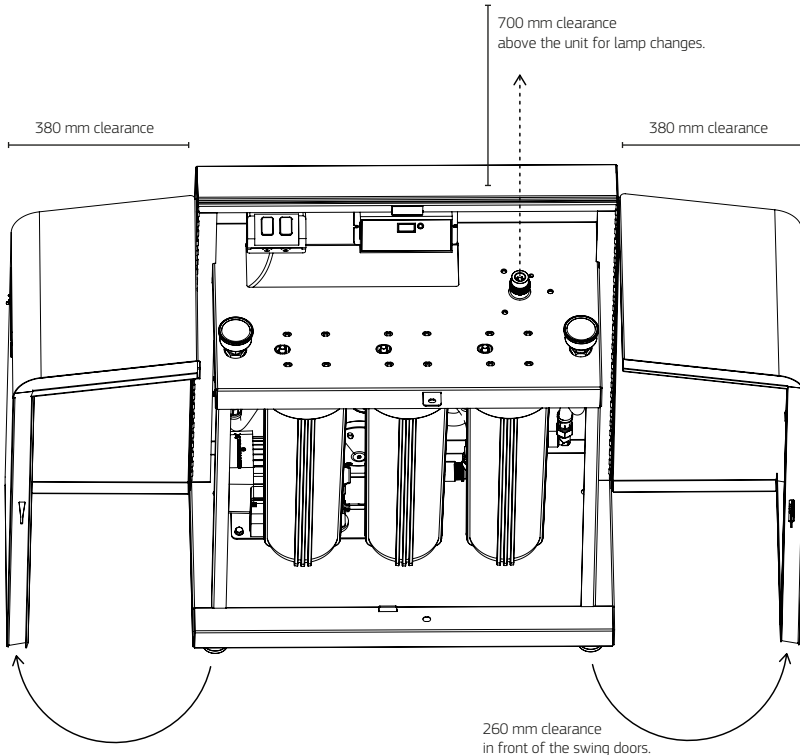

Fig 6. Installation Clearance



1. Before attempting installation check the unit to ensure the quartz sleeve is intact within the Radfire UV chamber.
2. Locate a suitable position for the HybridPlus system, remembering to allow 380 mm either side of the unit, 260 mm in front of the unit for the swing doors and 700 mm clearance above the unit for lamp changes (see Fig 5). A power outlet is required.

3. The HybridPlus can remain on the adjustable feet without mounting/anchoring the unit.

BOLTED INSTALLATION For the prevention of vandalism, movement subject to vibrations etc. The system can be bolted to a steady platform/concrete slab.

- a. First, you will need to remove the housing bowls and cartridges from the system to allow access room. If the bowls are difficult to undo, the spanner provided may be used to make it easier. Note which order the cartridges are in to ensure when they are re-installed they are in the same order.
- b. Drill the holes for the anchors into the platform or slab. Unscrew and remove the feet from the bottom of the cabinet. Locate the anchor holes inside the bottom of the unit and secure the unit in place using stainless steel anchor bolts with a maximum diameter of 12mm & a minimum length of 125mm (not included). See Fig. 7 for details.
- c. Once secure, re-install the cartridges and housing bowls. Hold bowls upright while screwing in the housings. Make certain that the spigot in the housing heads is located centrally to the cartridges to make a good seal. Use the provided spanner to tighten filter bowl until firm. **DO NOT OVER TIGHTEN.**

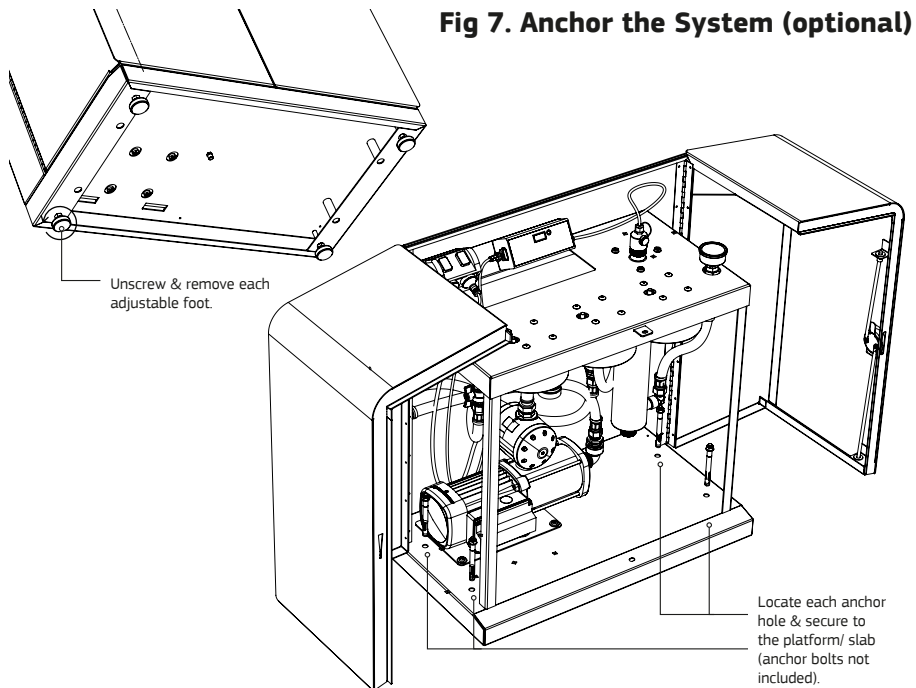

6. Turn the water off and purge the lines.
7. Plumb inlet and outlet pipe work to the Hybrid unit. Both the inlet and outlet are a 25 mm female brass connection.

Warning: Use PTFE thread seal tape on all connections. Use of pipe sealants will void warranty.

8. Open the swing doors to the unit.
9. Remove the safety cap from the aluminium nut, if the nut is inadvertently loosened during this process, retighten the nut. Insert the spring into the ballast by dropping it into the chamber. Slowly insert UV lamp into chamber through the hole of the aluminium nut end. Connect the lamp connector to the pins on the lamp. Do not let go of the lamp until the lamp is connected to the socket (see Fig. 8 & 9).

Never touch the quartz (glass) and lamp surface as marks or fingerprints may interfere with UV transmission. If lamp is soiled, please clean lamp with an alcohol based cleaner.

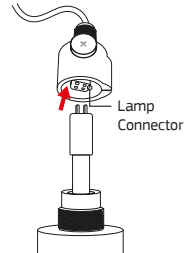

Fig. 8

10. Put safety cap on the aluminium nut. Connect the ground wire to the chamber. Plug in power connector.
11. Check the main power cord for the unit is plugged in and the power is on.
12. Check each housing bowl and ensure they have not become loose in transport. Use the provided spanner to tighten filter bowl until firm. **DO NOT OVER TIGHTEN.**
13. **(Pump Models Only)** Check the power cord for the pump is plugged in (power is off).
14. **(Pump Models Only)** Ensure that water is reaching the pump, this may require siphoning the line to begin water flow.
15. **(Pump Models Only)** Turn on the power to the pump.
16. Turn the water on, let the water flow through – opening a tap downstream to flush the unit for 1-2 minutes. Then check the system thoroughly for leaks.

Note: For initial use, wait 3-5 minutes to allow water to pass through the whole unit. Turn on a downstream tap to let water flow through the unit for 2-3 minutes to release air and impurities from the system.

17. Turn the power to the UV system on and ensure that the lamp is operating. Make sure that the GREEN LED is illuminated (refer Lamp Replacement Procedure on pg.14).
18. Close and lock the swing doors. Note: Your cabinet comes with 2 keys for your convenience. Please store them safely.

Note: Lost or misplaced keys are not covered by warranty.

Fig. 9 UV Lamp Diagram

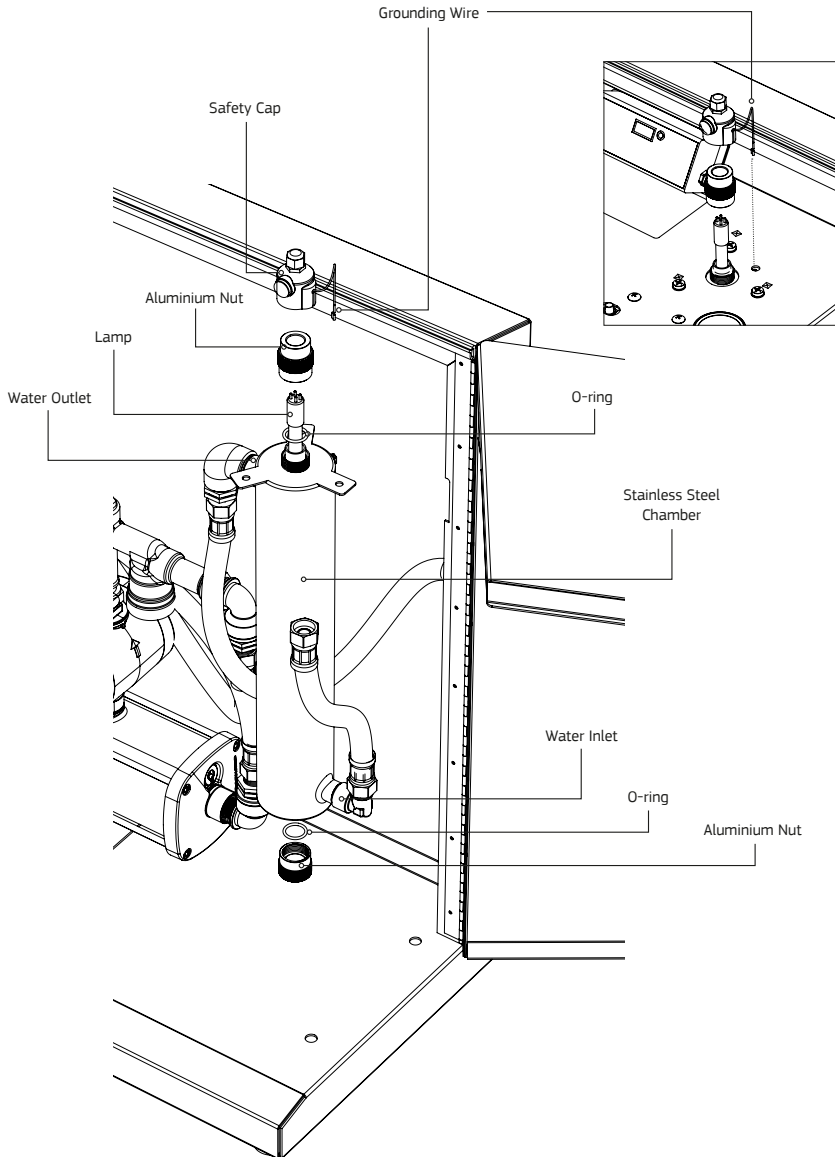

Operation

- Allow two minutes for the UV lamp to reach full intensity before using the outlet water.
- On a new installation where no other form of sterilisation has been in use, we recommend flushing the pipe work with a suitable sanitiser such as TankSafe™ (for dosage refer to TankSafe™ product instructions). This solution should be left in the pipework for at least an hour and preferably overnight.

The sanitising solution can be added into the water tank or if necessary added as a shock dose into the bowl of the filter housing of the HybridPlus and slowly flushed through the piping. If added as a shock dose the system and pipework should be rinsed thoroughly by opening a downstream tap.

Radfire UV Unit

- Prior to performing any work on the UV steriliser system, always disconnect the power supply.

Warning: *Do not look directly into ultraviolet rays emitted from the UV lamp as they will cause serious burns to unprotected eyes.*

- The treated water will seem warm for a short period at first flow. This is because the UV lamp emits heat. When turning on a tap, let the water run for a short time to purge any warm water.

Lamp Ballast Operation

Press the mode button to cycle the display between lamp life remaining and total running days.

Press and hold the silver button for 15 seconds to reset lamp life timer or until 'reset' appears on the screen.

To silence the 'lamp life end' alarm for 7 days, press and hold on the silver button until 'delay' appears on the screen.

Lamp Ballast Specifications

AC 240V | 50Hz

Lamp Power: 35W~95W

Lamp Current: 0.8A~0.9A

Ambient Temperature: 4~40°C

Lamp Rated Life: 365 days

Caution: Ground the ballast casing to avoid possible high voltage shock hazard

Replacement Parts Guide

To maintain a high quality of purified water, the cartridges will need changing periodically (dependent on water quality and usage).

You can obtain replacement cartridges from your local Puretec dealer. To maintain performance, warranty and Australian Standards use genuine Puretec replacements.

Replacement Parts:	Stage 1 Cartridge*	Stage 2 Cartridge	Stage 3 Cartridge	UV Lamp	Quartz Sleeve
HYBRIDPLUS (ALL MODELS)	PL05MP2	CB05MP2	PX01MP2	RL6	RQS6

Replace cartridges every 6 - 12 months dependant on water quality. UV Lamps must be replaced annually in order to maintain 99.9% kill rate of bacteria.

**Stage 1 Cartridge is nearest to the water inlet.*

Fig. 10 Cartridge Replacement Diagram

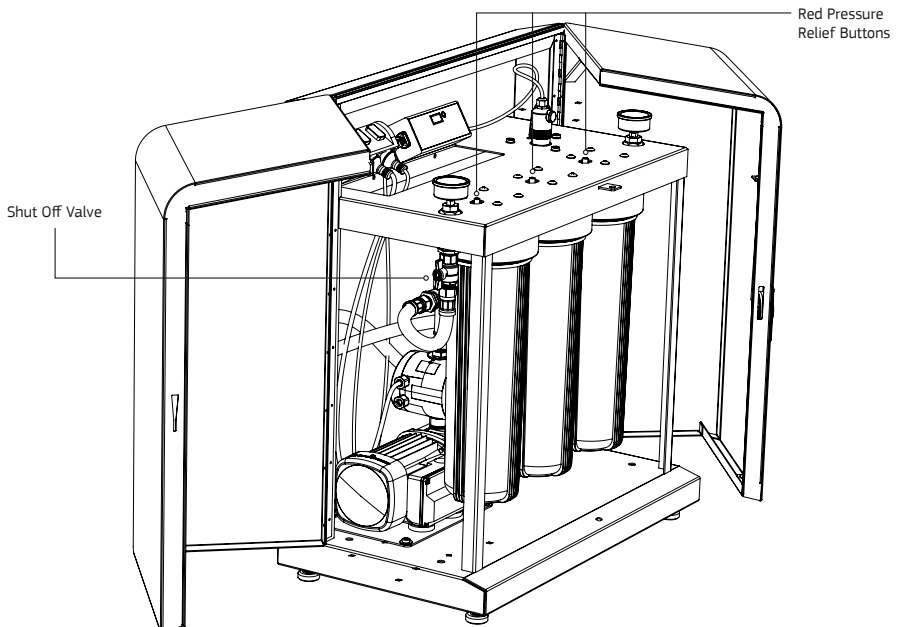

Cartridge Replacement Procedure

To change the filter cartridges please adhere to the following procedure:

- 1 Turn water supply off and relieve pressure by opening a downstream tap or pressing the red pressure relief button on the housings.
- 2 Unscrew the filter bowls anticlockwise. If the bowl is difficult to undo, the spanner provided may be used to make it easier. Remove old cartridges and dispose in the correct manner.
- 3 Clean bowls with Puretec Housing Sanitiser or detergent and warm water and then rinse thoroughly. Check O-Rings for damage and replace if necessary.
- 4 Check the O-ring lubrication and if necessary apply a light coating of food grade silicone lubricant (or similar).
- 5 Remove all packaging from new filter cartridges and insert into housing bowls making sure cartridges are properly seated over the spigot in base of the bowls.
- 6 Hold bowls upright while screwing into the housings in a clockwise direction. Make certain that the spigot in the housing heads is located centrally to the cartridges to make a good seal. Tighten the bowls until firm. Use the spanner to tighten the bowls until firm. **DO NOT OVER TIGHTEN.** Remember to record the model number of the cartridges you use & install date.
- 7 Open a downstream tap to allow air to be released and gently open water supply allowing all air to be purged.
- 8 Allow water to run for 1-2 minutes to flush the system.
- 9 Close down stream tap and check the Hybrid system for leaks. Flush system for 1-2 minutes after any period of non-use more than 2 weeks. For a period of non-use of 6 months or more, it may be necessary to replace the cartridges.

Lamp Replacement Procedure

Prior to performing any work on the UV steriliser, always disconnect the power supply first.

- 1 Turn water off and release the water pressure.



Parts become hot during operation.
Allow to cool before servicing.

- 2 Unlock and open the cover if you have a Hybrid G model. Disconnect the lamp connector and ground wire. Grip the end of the lamp and carefully disconnect the power socket.

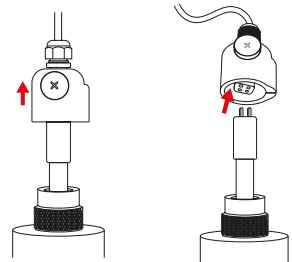

Fig. 11

Slowly remove the old lamp from the chamber.

3. Check the quartz sleeve to ensure it is clean and intact (*see steps 4 - 8 of Quartz Sleeve Maintenance/Replacement Procedure on page 18*).
4. Remove the packaging on the new lamp. Slowly insert into chamber through the hole of the aluminium nut end. Connect the lamp connector to the pins on the lamp. Do not let go of the lamp until the lamp is connected to the socket (*see Fig. 6*).

Never touch the quartz (glass) and lamp surface as marks or fingerprints may interfere with UV transmission. If lamp is soiled, please clean lamp with an alcohol based cleaner.

5. Secure the lamp connector on the aluminium nut end. Connect the ground wire to the chamber. Plug in power connector, the RED LED will be illuminated (when the lamp life timer is reset in step 7 the LED will turn green).
6. Restore water supply and check the unit for leaks. Re-check the unit after 1 hour.

Note: For initial use, wait 3-5 minutes to allow water to pass through the whole unit. Turn on a downstream tap to let water flow through the unit for 2-3 minutes to release air and impurities from system.

7. Press and hold the silver button for 15 seconds, when an audible "beep" will sound, indicating that the lamp life timer has been reset for a further 12 months.

- If you have the Hybrid G model, close and lock the lid. Note: Your cabinet comes with 2 keys for your convenience. Please store them safely.

Note: Lost or misplaced keys are not covered by warranty. We recommend replacing UV lamp annually to ensure high sterilising rate with best water quality. Always keep UV lamp on, as power fluctuation will shorten the service life of the UV lamp.

Quartz Sleeve Maintenance/Replacement Procedure

To ensure high sterilising rate with best water quality, check sleeve regularly (about every 3 months depending on quality of water source) and see whether there is dirt or substances gathered. Allow the unit to cool before servicing. Prior to performing any work on the UV sterilizer, always disconnect the power supply.

Fig. 12

- Turn off the power and water to the unit and release the water pressure (using the red buttons above the unit's filters).



Parts become hot during operation.
Allow to cool before servicing.

- Unlock and open the cover if you have a Hybrid G. To disconnect the Lamp Connector, detach the earthing wire, grip the white Cap and carefully disconnect from the Aluminium Nut.
- Slowly remove the UV Lamp from the chamber.
- Unscrew and remove the Aluminium Nut on the top of the chamber. Now remove the Aluminium Nut from the bottom of the Stainless Steel Chamber, securing the Spring and Quartz Sleeve.

Important: Be aware that the water within in will be discharged through the bottom of the Stainless Steel Chamber once the bottom Aluminium Nut is removed.

Important: The Quartz Sleeve may come through the base of the chamber after the bottom Aluminium Nut is removed, hold the bottom of the Quartz Sleeve and remove the bottom O-Ring.

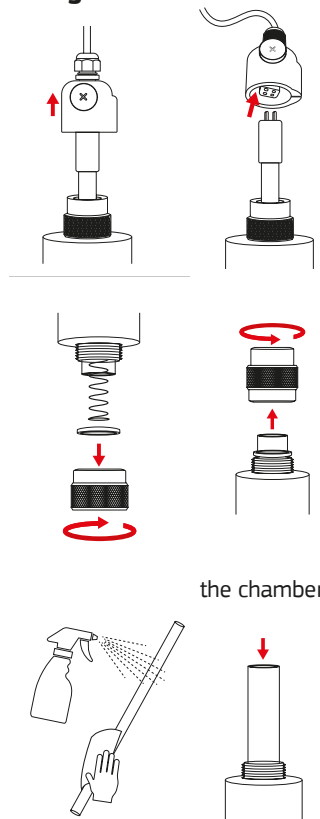

- Slide the Quartz Sleeve through and out of the top of the chamber.

Fig. 13

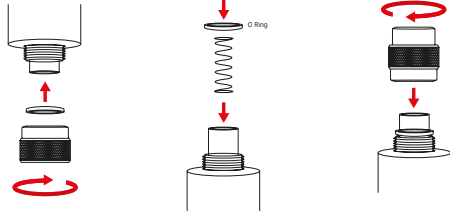

- Clean the Quartz Sleeve with Puretec Quartz Sleeve Cleaner. If the glass will not come up clear/clean you will need to install a new replacement Quartz Sleeve. If you need to purchase a new sleeve, for now continue with the next steps and install the new sleeve once you have received it.

- Placing an O-Ring on the new or cleaned sleeve, leaving approx. 1 inch from the end and Slide the Quartz Sleeve into the top of the chamber and carefully slide down through the bottom opening of the chamber until the o-ring sits on top of the chamber as shown.

Fig. 14

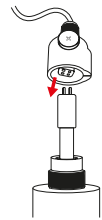

- Place the bottom O-Ring on the Quartz Sleeve and screw the bottom Aluminium Nut on to the chamber. Gently tap the sleeve on the top to ensure that it's sitting firmly on the bottom Aluminium Nut and then screw the top Aluminium nut back on and drop the spring into the quartz sleeve as shown.
- Slowly insert UV lamp into chamber through the hole of the Aluminium Nut at the top of the chamber. Connect the lamp connector to the pins on the White Lamp Socket. Do not let go of the lamp until the lamp is securely connected to the socket.

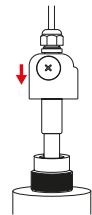

Never touch the quartz (glass) and lamp surface as marks or fingerprints may interfere with UV transmission. If lamp is soiled, please clean lamp with an alcohol based cleaner.

cont. over page.

cont

10. Connect the four pins on the end of the lamp to the socket in the white cap. Slowly insert UV lamp into the top of the chamber. Connect the earthing wire to the chamber and plug in the ballast power connector and turn the power on.

To reset the count-down timer, press and hold the silver button for 15 seconds until 'reset' is shown on the screen and a single beep is heard. The display will show 365 days and the green 'on' LED will be lit.

11. Restore the water supply and check the unit for leaks. Turn on a downstream tap to let the water flow through the unit for 2-3 minutes to release any air and impurities from the system. Check the unit again after 1 hour for leaks.

Note: For initial use, wait 3-5 minutes to allow water to pass through the whole unit. Turn on a downstream tap to let the water flow through the unit for 2-3 minutes to release any air and impurities from system.

12. Close and lock the doors. Your cabinet comes with 2 keys for your convenience. Please store them safely.

Note: Lost or misplaced keys are not covered by warranty.

SYMPTOMS	POSSIBLE CAUSE	POSSIBLE SOLUTION
No power.	<ul style="list-style-type: none"> • Power cord has been disconnected. • Ballast and/or breaker tripped. • Ballast damaged. 	<ul style="list-style-type: none"> • Check power connections. • Reset ballast and/or breaker. • Replace ballast.
Ballast or breaker repeatedly trips.	<ul style="list-style-type: none"> • Connection between lamp and lamp plug is wet. • Short-circuit in the electrical assembly. 	<ul style="list-style-type: none"> • Clean and dry lamp pins and lamp plug, check unit for leaks or condensation. • Replace ballast.
Leak at inlet or outlet.	<ul style="list-style-type: none"> • Threaded pipe fittings are leaking. • Cracked heads. 	<ul style="list-style-type: none"> • Clean threads, reseal with Teflon tape and retighten. • Replace heads.
Leak detected from area of UV chamber.	<ul style="list-style-type: none"> • Condensation of moist air on cold chamber (slow accumulation). • O-ring damaged, deteriorated or incorrectly installed. • Lamp/sleeve assembly not properly installed (too tight or not tight enough). 	<ul style="list-style-type: none"> • Control humidity or relocate unit. • Inspect and replace if deteriorated. • Check O-rings are in place. • Tighten assembly hand-tight.
System is operating but water tests reveal bacterial contamination.	<ul style="list-style-type: none"> • Equipment downstream of UV system is acting as a breeding ground for pathogens. • Pathogens are residing in the distribution lines post-UV. • Lamp reached the maximum lamp life. 	<ul style="list-style-type: none"> • Ensure UV is the last piece of treatment equipment. Ensure all distribution lines have been disinfected - see page 10. • Remove any pipe dead-ends and flush with chlorine. • Replace lamp on or before lamp counter reached 0.
Lamp timer does not read anything.	<ul style="list-style-type: none"> • Unit is unplugged. • No power at AC power outlet. • Power cord is damaged. • Power surge caused damage to electrical assembly. 	<ul style="list-style-type: none"> • Plug unit into AC power outlet. • Replace fuse or reset breaker. • Replace power cord. • Replace ballast.

cont. over page.

SYMPTOMS	POSSIBLE CAUSE	POSSIBLE SOLUTION
Leak detected at filters.	<ul style="list-style-type: none"> • O-ring damaged, deteriorated or incorrectly installed. • O-rings dry. • Filter cartridge not centered. 	<ul style="list-style-type: none"> • Remove the sump, wipe the O-ring and threads clean. Ensure the O-ring is fitted properly, then reinstall. • Lubricate O-rings with suitable sealant. • Remove sump, check for cartridge damage, re-assemble ensuring cartridge is centered.
Red lamp blinks and buzzer sounds.	<ul style="list-style-type: none"> • Lamp has reached or nearing the maximum lamp life. • Lamp is disconnected or faulty. 	<ul style="list-style-type: none"> • Replace lamp on or before lamp counter reached 0. • Check lamp connection, replace if needed.
Display flashing.	<ul style="list-style-type: none"> • Power interruption. 	<ul style="list-style-type: none"> • Reset ballast.
Error Code 'A3' on ballast.	<ul style="list-style-type: none"> • Ballast countdown has reached 0, lamp life expired. 	<ul style="list-style-type: none"> • Replace lamp.
Loud pump / vibration	<ul style="list-style-type: none"> • Supply line too small 	<ul style="list-style-type: none"> • Increase supply line to 25 mm or larger.
No water.	<ul style="list-style-type: none"> • Water is not reaching the pump. 	<ul style="list-style-type: none"> • Siphon the water line ahead of the pump.

For pump troubleshooting refer to your pump user guide for manufacturer's instructions.

HybridPlus P3, P6, P9 & P12 models include a Grundfos pump guide with your unit, please refer the Grundfos guide for troubleshooting or for assistance please ring the Puretec Customer Service Helpline on 1300 140 140 (AU) or 0800 130 140 (NZ).

Note

3 Year HybridPlus Puretec warranty excludes the Grundfos Pump which is covered by the Grundfos back-to-base 2 year warranty.

Warranty

Any claim under this warranty must be made within 3 years of the date of purchase of the product. This product is warranted to be free of defect of material and workmanship for 3 years from date of purchase. 3 year warranty is 1 parts and labour, plus 2 years parts only. Excludes cartridges, consumables and pump (pump is backed by Grundfos 2 year warranty, visit www.grundfos.com for details).

Puretec is renowned for its quality and after-sales support so if you have any issues please call 1300 140 140 (AU) or 0800 130 140 (NZ). To make a warranty claim, contact us directly or the place of original purchase. All costs relating to a warranty claim must be approved by Puretec prior to any work being carried out.

Puretec will pay your reasonable, direct expenses of claiming under this warranty. You may submit details and proof of your expense claim to place of purchase for consideration.

The warranty only applies if the product was used and/or installed in accordance with the user guide and/or installation instructions. This warranty is given in lieu of all other express or implied warranties and manufacturer shall in no circumstance be held liable for damages consequential or otherwise or delays caused or faulty manufacturing except as excluded by law.

Applicable to all above, is that the warranties need to be approved by Puretec to ensure product was not incorrectly used, installed or claimed. False and incorrect claims will be pursued at Puretec's discretion, including chargeable inspection and labour costs incurred.

Warranty/Australia

This warranty is given by Puretec Pty Ltd, ABN 44 164 806 688, 37-43 Brodie Road, Lonsdale SA 5160, telephone no. 1300 140 140 and email at sales@puretec.com.au.

This warranty is provided in addition to other rights and remedies you have under law: Our goods come with guarantees which cannot be excluded under the Australian Consumer Law. You are entitled to replacement or refund for a major failure and to compensation for other reasonably foreseeable loss or damage. You are also entitled to have the goods repaired or replaced if the goods fail to be of acceptable quality and the failure does not amount to a major failure.

Warranty/New Zealand

This warranty is given by Puretec Ltd, Reg. No 4464398, PO Box 875 Cambridge 3450 NZ, telephone no. 0800 130 140 and email at sales@puretec.co.nz.

This warranty is provided in addition to other rights and remedies you have under law: Our goods come with guarantees which cannot be excluded under the Consumer Guarantees Act. You are entitled to replacement or refund for a major failure and to compensation for other reasonably foreseeable loss or damage. You are also entitled to have the goods repaired or replaced if the goods fail to be of acceptable quality and the failure does not amount to a major failure.

This page was intentionally left blank.



AUSTRALIA

P 1300 140 140

E sales@puretec.com.au

W puretec.com.au

NEW ZEALAND

P 0800 130 140

E sales@puretec.co.nz

W puretec.co.nz