

Say 'no' to scale
in your home.



Protect your home with Puretec Softrol™.



Customer Support



Established Manufacturer



On-the-Road Support



AUSTRALIA

Customer Service: 1300 140 140
Email: sales@puretec.com.au
Web: www.puretec.com.au

NEW ZEALAND

Customer Service: 0800 130 140
Email: sales@puretec.co.nz
Web: www.puretec.co.nz



Soft water benefits from a superior water softener appliance.

Use less detergents. Clean bathrooms and dishes more easily. Reduce scum, towels and linen are softer and appliances last longer. The benefits are almost endless, and shouldn't be underestimated.

Puretec Softrol's guaranteed systems combine the latest in innovation and 25 years of experience in the harshest environments.



Insist on a WaterMark certified softener.

The Softrol system is manufactured to stringent standards.

Watermark certification confirms that the product complies with the Plumbing Code of Australia and the relevant Australian standards. This relates to product quality, including health and safety and warrants that the product is fit for purpose.



Softrol™ benefits around your home.



Dishwasher

Your glassware is now clear and shiny with no scale, smears or spots. Appliances can wear out up to 40% faster without soft water.



Bathroom

It's easier to wash soap and shampoo out completely, leaving skin and hair cleaner, softer, residue free and looking much better! The shower screen is easier to clean too.



Laundry

Clothes are much softer, look whiter & brighter and use up to 50% less detergent when washed. Appliances will also last longer.



Rumpus Room

Drinks mixed with Softrol™ water simply taste better. So do juices. Now ice cubes look clearer and more appealing.



Utility Area

Your Puretec Softrol™ protects against premature hot water system replacement and many other appliances / fixtures.



Kitchen Tap

Enjoy peace of mind knowing your Softrol™ water is always pure and refreshing. Prepared foods taste more natural. Fruit and vegetables rinsed in Softrol™ water are more appetising.



Car

You'll enjoy washing your car again with a spot-free finish.



Cleaning Cupboard

Clean-up chores are easier thanks to the tremendous cleaning action of Softrol™ water. Clean-up is more economical because you'll need far less household cleaner.



Hard water is water that contains dissolved minerals such as limestone, iron, sulphur, magnesium, and calcium. If these minerals are not removed from your water, they will cause scaling, eventually blocking plumbing and shortening the life of appliances, particularly hot water units, dishwashers, washing machines etc.

Luxurious Water

With Puretec Softrol™ your silverware and glassware, are cleaner and shinier. Your hair and skin feels softer, cleaner and smoother. Puretec Softrol™ helps rinse soap residue more thoroughly, leaving your clothing and dishes as well as your hair and skin looking and feeling cleaner.

Longevity

Minerals found in hard water build up in household appliances such as hot water systems and dishwashers reducing their service life and making them less efficient. Obviously, soft water saves you money by replacing them less often and saves the environment by cutting waste.

Efficiency

Water softened with a Puretec Softrol™ water softener appliance heats up faster. This saves on power and gas consumption at a massively reduced rate. An estimated 22% for electric hot water systems and 30% for gas hot water units.

Robust

Our impeccable manufacturing standards are derived from our commercial operations, where there's no margin for error. The products have been tested in the harshest environment and every Puretec Softrol™ comes with a 6 year warranty.

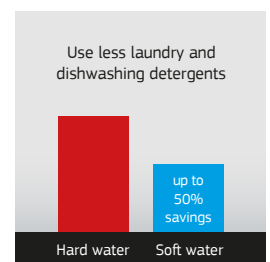
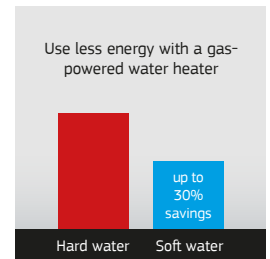

Simple & Smart...



State-of-the-Art E3 Valve (E3 model only)

If no water is used it won't backwash. When it does, according to the water volume used and water quality, it will choose a convenient time when water generally isn't used.

User Friendly, Functional Controller

Solid-state microprocessor with easy access front panel settings. Backwash controller has less moving parts for reliability.



Easy Lid Access

Functional lid design keeps the dirt out and a large opening means easy topping up of the brine tank.



Water, Energy and Money Saving (E3 model only)

The integrated water meter monitors usage for precise regeneration and efficient salt usage. Backwash controller has less moving parts for reliability and durability.

High Grade Premium Resin

This means less regeneration needed, higher capacity per unit and longer resin life.

Durable Cabinet

Polyethylene body, durable and designed for the harshest environment. Includes a weather cover for outdoor installation.

Sliding water proof cover

Ergonomic cover for easy maintenance with the new sliding cover.



Easy access controller

Easy access to the controller for programming and maintenance.



Salt Chute

Effortless salt refilling.





How it works

1. Untreated water passes through the water softening resin.
2. Resin softens water by reducing ions such as calcium and magnesium.
3. Water enters your home, providing the benefits of soft water throughout the house.
4. The system periodically uses a salt (brine) solution to cleanse and recharge the resin, whilst releasing the hardness and other impurities down the drain.



Untreated Water

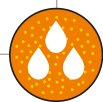

Softening Resin

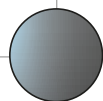

Brine Tank

A. Control Valve

B. Inlet

C. Outlet

Technical support

Call our helpline for free assistance at **1300 140 140** (AU) **0800 130 140** (NZ) or visit our website [puretecgroup.com](https://www.puretecgroup.com).

Select from the advanced Puretec Softrol™ controllers

Parameters / Model

SE
model

E1
model

E3
model

Watermark Approved
6 Year Warranty
Made in USA
Rigid Reinforced Design
Durable Polyethelene Cabinet
Easy Access Salt Chute
High Grade Filtration Media
Technical Phone Support
Large Capacity Brine Tank
Integrated Weather Cover
LCD Error Reporting
Select Time Of Day Regen
Automatic Regeneration
Integrated Water Meter
Automatic Capacity Calculator
Advanced Salt Efficiency

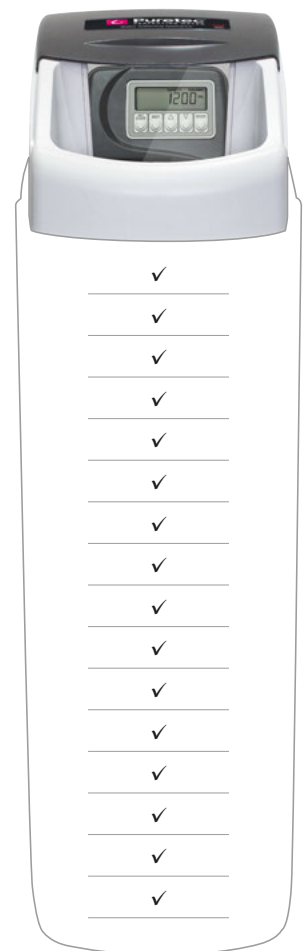
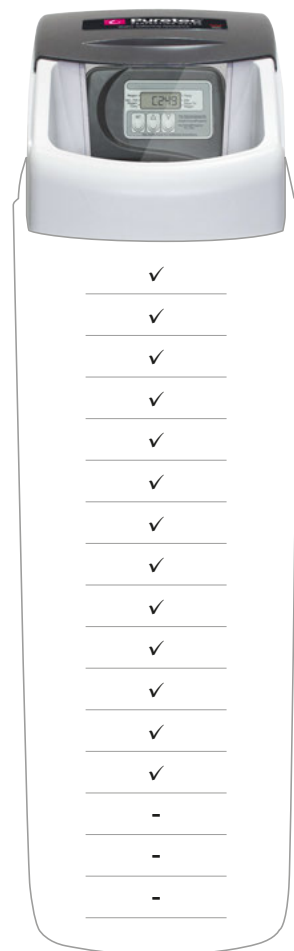
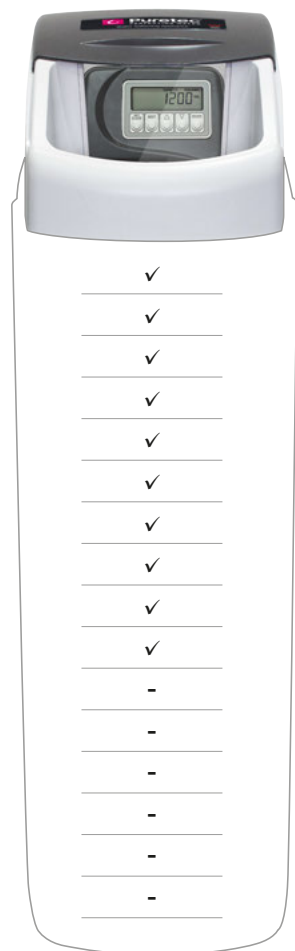

Puretec Softrol™ Optional Accessories



Spanner
Suits E1 & E3 Valve
Ordering Code: **WTV5180**



Bypass Assembly
Suits E1 & E3 Valve
Ordering Code: **WTV5000**

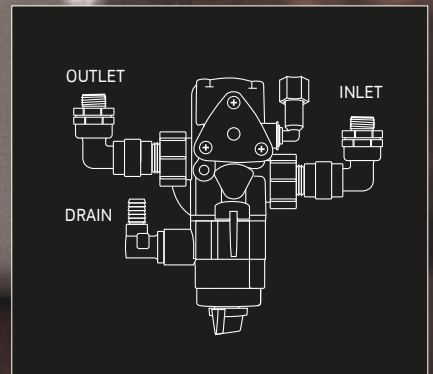
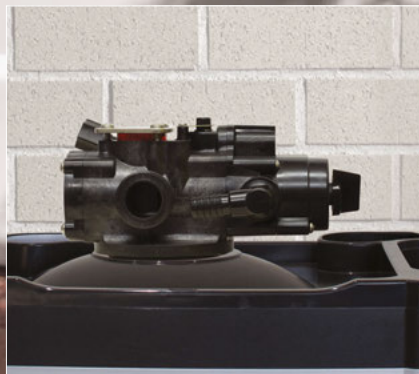
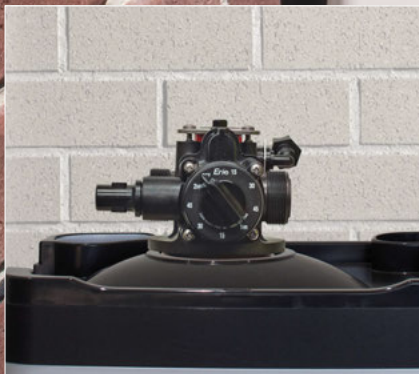

Softrol™ SOL-SE Series

The Softrol™ SOL-SE semi-automatic water softening systems are our most economical units. Requiring no power, the unit incorporates a unique twist timer. Simply twist the timer to initiate a regeneration when necessary and the unit regenerates for the nominated time then returning back to normal softening mode.

Whole house protection

These systems provide peace of mind and water softening throughout the house. You'll notice benefits all through the house. Soap and shampoos will lather better, your skin will be softer, and soap scum will be reduced. Clothes are softer and hot water appliances will last many more years.



Easy to maintain, no power required

The Puretec SOL-SE Series systems are designed for the budget-conscious householder. These systems do not require power to operate. Very easy to maintain. Simply twist the timer to initiate a regeneration when necessary and the unit regenerates for the nominated time before returning back to normal softening mode.

Features

- No power required.
- Weather cover for outdoor installation.
- Large capacity brine tank.
- Semi-automatic twist timer.
- Simple, durable and very reliable.



Available Models	SOL30-SE	SOL40-SE
Size of Residence	 Small to Medium	 Medium to Large
Service Flow Rate	30 Lpm	40 Lpm
Maximum Flow Rate	80 Lpm	80 Lpm
Min/Max Pressure	138 - 825 kPa	138 - 825 kPa
Capacity	12,000 L*	18,000 L*
Connection	20 mm F or 15 mm M [¾" F or ½" M]	20 mm F or 15 mm M [¾" F or ½" M]
Drain	12.5 mm tube	12.5 mm tube
Warranty	6 Years [^]	6 Years [^]

*Based on a hardness of 130ppm

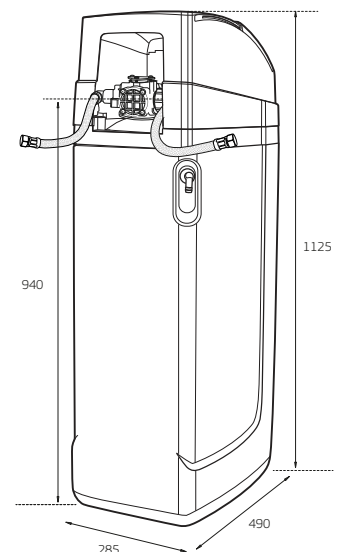

Dimensions in millimeters

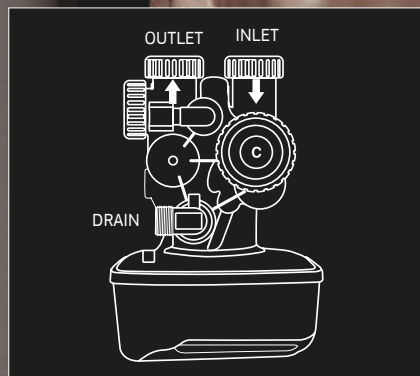

Softrol™ SOL-E1 Series

The Softrol™ SOL-E1 Automatic Timer water softening systems requires less maintenance than the semi-auto systems. After the initial installation simply set the times and dates requiring backwash and the unit regenerates automatically.

Whole house protection

These systems provide peace of mind and water softening throughout the house. You'll notice benefits all through the house. Soap and shampoos will lather better, your skin will not be as dry, and soap scum will be reduced. Clothes are softer and hot water appliances will last many more years.



Easy to maintain, set and forget

The Puretec SOL-E1 Series systems uses an E1-Matic™ valve that backwashes automatically on a preset time. After the initial installation, simply set the times and dates requiring backwash and the unit automatically regenerates. Power usage is extremely low, similar to that of a garden watering system.

Features

- Regenerates automatically.
- 1 - 99 day timer controller.
- 10 selectable programmed cycles.
- 12 volt transformer.
- Reliable, durable and simple.



Available Models	SOL30-E1	SOL40-E1
		
Size of Residence	Small to Medium	Medium to Large
Service Flow Rate	30 Lpm	40 Lpm
Maximum Flow Rate	100 Lpm	100 Lpm
Min/Max Pressure	138 - 825 kPa	138 - 825 kPa
Capacity	12,000 L*	18,000 L*
Connection	25 mm M [1" M]	25 mm M [1" M]
Drain	15 mm tube	15 mm tube
Power Required	240 V	240 V
Warranty	6 Years [^]	6 Years [^]

*Based on a hardness of 130ppm

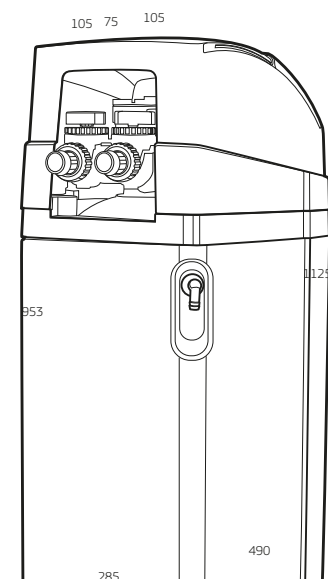

Dimensions in millimeters

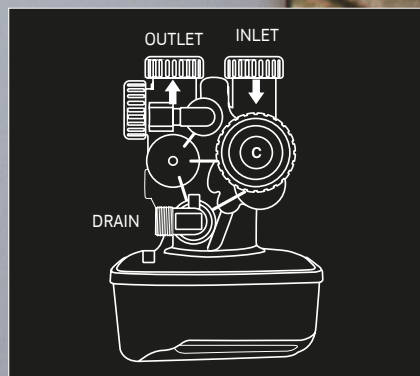

Softrol™ SOL-E3 Series

The Softrol™ SOL-E3 Automatic Volume water softening system is our smartest unit. Just input the water hardness, time and date and the unit automatically calculates the capacity. It measures the water volume used and initiates a regeneration once the capacity is reached.

Saves water, time and money.

Whole house protection

These systems provide peace-of-mind water softening throughout the house. You'll notice benefits all through the house. Soap and shampoo's will lather better, your skin will not be as dry, and soap scum will be reduced. Clothes are softer and hot water appliances will last many more years.



Reliable, durable, simple and almost maintenance free

The Puretec SOL-E3 Series systems uses an E3-Matic™ valve and is the most advanced water softener valve. If no water is used it won't backwash and then when it decides to, it will choose a convenient time when you never use water. Power usage is extremely low similar to that of a garden watering system. Very simple and easy to use.

Features

- Less salt, water, power consumed with the metered control valve.
- Optimum regeneration, cleaning and efficiency.
- 36 selectable pre-programmed cycles, 3 modes of backwashing.
- Highly intelligent use of water.
- 1 - 28 days override.
- 1 - 99 day timer or 7 day timer controller.
- Reliable, durable and simple.



Available Models	SOL30-E3	SOL40-E3
		
Size of Residence	Small to Medium	Medium to Large
Service Flow Rate	30 Lpm	40 Lpm
Maximum Flow Rate	100 Lpm	100 Lpm
Min/Max Pressure	138 - 825 kPa	138 - 825 kPa
Capacity	12,000 L*	18,000 L*
Connection	20 mm F or 15 mm M [¾" F or ½" M]	20 mm F or 15 mm M [¾" F or ½" M]
Drain	15 mm tube	15 mm tube
Power Required	240 V	240 V
Warranty	6 Years [^]	6 Years [^]

*Based on a hardness of 130ppm

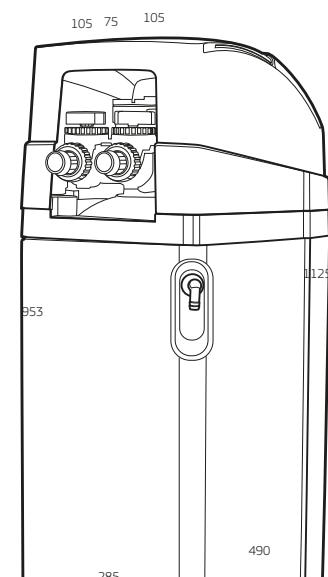

Dimensions in millimeters



AUSTRALIA

Customer Service: **1300 140 140**

Email: sales@puretec.com.au

Web: www.puretec.com.au

NEW ZEALAND

Customer Service: **0800 130 140**

Email: sales@puretec.co.nz

Web: www.puretec.co.nz

Puretec water care products are designed, manufactured and supported by Puretec Ltd the name you can trust for viable and proven water solutions. The complete range of Puretec products are developed, refined, made to meet and exceed stringent specifications for the worldwide market. All pictures and information are supplied as a guide only. Fittings not Included.

Important Note: Sales of products are subject to our Terms and Conditions which are available upon request. All specifications, information and photos are a guide only and are subject to change without notice. Please ring to confirm details. Warning: For correct operation of this appliance it is essential to observe manufacturer's instructions. Caution: Do not use with microbiologically unsafe water or water of unknown quality without adequate disinfection before or after the system. Under normal circumstances a pressure limiting valve is not required. However, if incoming water pressure exceeds 875 kPa, a pressure limiting valve must be fitted prior to inlet. *6 year warranty is 1 year parts and labour and 5 years parts only. Copyright © Puretec Ltd 2019.