

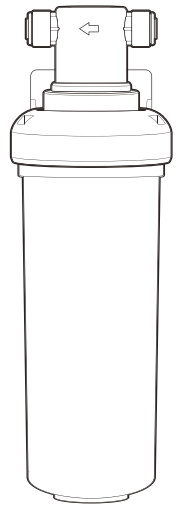

Puretec[®]
PERFECTING WATER



User Guide

Z1-MW-K

Quick Twist Undersink Water Filter Kit



WaterMark

AS/NZS 3497
Licence No. WM 74726
Australian Certification
Services

What's Inside

Operation	3
Cartridge Replacement.....	3
Installation Requirements and Procedure	3
Cartridge Changeout	4
Use Guidelines	5
Performance Data.....	8
Warranty.....	9

Puretec Customer Service

Thank you for purchasing a Puretec Quick Twist Undersink Water Filter System. Your system is a proven performer manufactured from only quality materials and components and will give years of 'spring fresh' water free of impurities if maintained properly.

The Puretec Z1-MW-K system cartridge needs replacing regularly to maintain optimum performance. This is a simple procedure when following instructions. For cartridge replacements contact your nearest Puretec stockist.

Customer Service Helpline **1300 140 140** (Australia) **0800 130 140** (New Zealand).

Caution: Do not use with water that is microbiologically unsafe or with water of unknown quality without adequate disinfection before or after the system.

Operation

The Puretec Z1-MW-K system is designed to run economically for many years dependent on the initial installation and periodical maintenance.

Flush systems for 10 minutes after any period of non-use more than 2 days. For a period of non-use of 2 weeks or more, it may be necessary to replace cartridge.

Cartridge Replacement

To maintain the high quality of the purified water cartridges need changing every 6 - 12 months (dependent on water quality and usage).

Order **Z1-R** for a replacement cartridge to suit your Z1-MW-K system.

Installation

This system comes complete with an installation kit enabling it to be connected to 15 mm (½") male thread. This product must be installed in accordance with local plumbing regulations by a licensed plumber.

Installation Note: A water filter system/tap, like any product, has a limited life and may eventually fail. Also sometimes failure happens early due to unforeseen circumstances. To avoid possible property damage, this product should be regularly examined for leakage and/or deterioration and replaced when necessary. A drain pan, plumbed to an appropriate drain or outfitted with a leak detector, should be used in those applications where any leakage could cause property damage, and/or the water supply should be turned off if no one is home/present.

Installation requirements

- 1 15 mm (½") Cold water line - mains only.
- 2 Supply pressure: 200 - 520 kPa.
- 3 Supply temperature 0° - 38 °C (protect from freezing).

Alternative fittings may be required if being connected to anything other than 15 mm (½") copper pipe. If connecting to a 3-way mixer, the mixer may have come with an adaptor, which could be used to connect this system to the filter line. No electrical or drainage requirements needed.

Installation Procedure

1. Select suitable location that is close to the point of filtered water delivery (eg. sink). Remember to allow access room for changing filters and a suitable place where water spillage will not cause damage. Location should not be in direct sunlight.
2. Isolate water supply. Uninstall the connections on the cold water line and connect the Smart Tee™ (see Fig. 3). Reinstall the previous connection to the tee valve.
3. Connect the pressure limiting MultiValve to the Smart Tee™ with a length of White Tubing.
4. If you have an existing filter tap proceed to step 5. If you have purchased a new faucet separately, install according to model instructions.
5. If you have an LED indicator on your faucet, reset it according to the model instructions.
6. Install filter cartridge by positioning it in the desired location, marking the position of fixing hole and fixing with bracket screw. The Z1-MW-K system can be mounted horizontally or vertically. Allow room for the connecting tubes. Ensure flow arrow on the head is in direction of water flow.
7. Fit tubing into connectors (for quick-connect fittings instructions see Fig. 2). Allow slack in the tubing.

8. Restore the water supply and check for leaks.
9. Run the system for at least 5 minutes to remove carbon fines. Water may appear milky, but this is normal and is only tiny air bubbles that will clear after a short period.

Cartridge Installation/Changeout

1. Rotate the old cartridge counterclockwise 1/4 turn, pull it out and dispose of it.
2. Remove all packaging from the new cartridge, including any wraps or caps (if applicable).
Replacement cartridge: **Z1-R**
3. Insert the new cartridge into the filter head and rotate clockwise 1/4 turn.
4. If you have an LED indicator on your faucet or 3-way mixer, reset it according to the model instructions.
5. Turn on the water and check for leaks. If leaks occur, repeat step 3. If leaks persist, discontinue use and call your supporting dealer.
6. Flush filter for 5 minutes before use or until water runs clear.

Use Guidelines

- Minimum operating pressure 200 kPa.
- Maximum operating pressure 520 kPa. If pressure exceeds 500 kPa, an approved pressure limiting device needs to be fitted.
- Do not allow exposure to temperatures below 0 °C, protect from freezing.
- Maximum operating temperature 38 °C (protect from freezing).
- Nominal flow rate 5.5 Lpm.
- This system must be installed according to local plumbing codes on the cold water line - mains only.
- Replacement Cartridge: **Z1-R**
- This system requires regular replacement of the filter cartridge to maintain proper operation. Varying chlorine, sediment, or organic substance levels may affect replacement frequency.
- Be sure to change the filter cartridge at least every 23,000 litres or 6 - 12 months which ever occurs first; or whenever you detect a change in taste, odour, or decrease in flow.

Figure 1

No.	DESCRIPTION
1	Smart Tee™ ½" M x ½" F x ¼" T
2	White Tubing
3	MultiValve
4	Z1-R Filter Cartridge
5	Mounting Bracket
6	3-Way Mixer or Filter Faucet (sold separately)

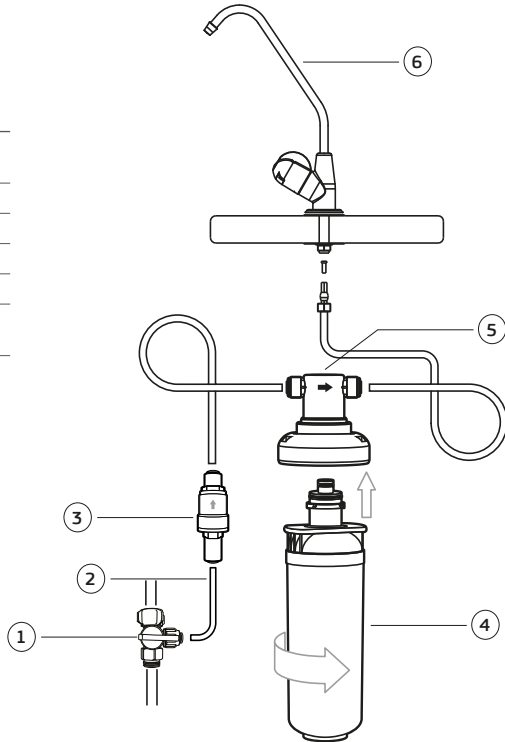

Figure 2

HOW TO USE QUICK CONNECT FITTINGS



1. Cut the tube square and push in to the tube stop. For metal tube remove burrs and chamfer tube end to prevent O-Ring seal being damaged.



3. Tube is secured in position.

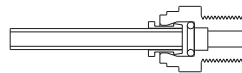

2. Fitting grips before it seals. Ensure tube is pushed in to tube stop.

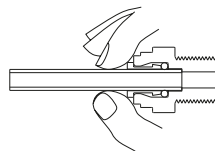

DISCONNECTION PROCEDURE

4. Push collet against body and slide tube out of fitting.

Figure 3 - SmartTee™ Quick Connect Fitting

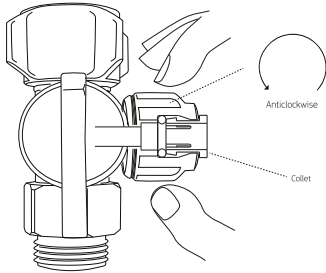

1. Turn the quick connect nut on the SmartTee™ anticlockwise to release the collet.

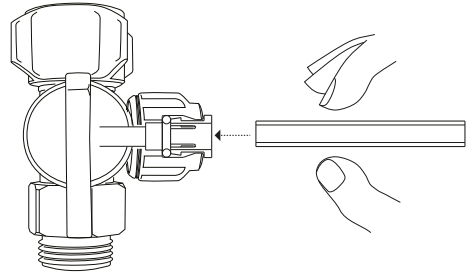

2. Cut the tube square and push into into the tube stop (inside the collet). For metal tube; remove burrs and chamfer tube end to prevent O-ring seal being damaged.

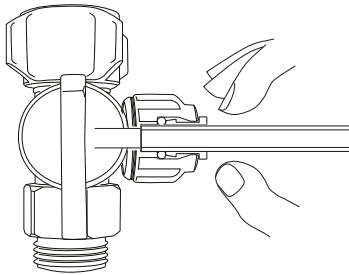

3. The fitting grips before it seals. Ensure the tube is pushed all the way into the tube stop.

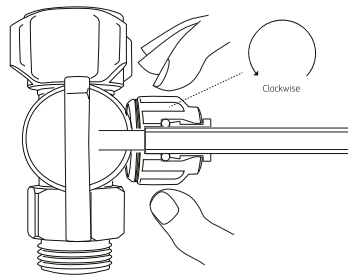

4. Once the tube is secured in position, turn the quick connect nut clockwise to secure.

Note: Hand tighten only. Do not overtighten.

DISCONNECTION PROCEDURE

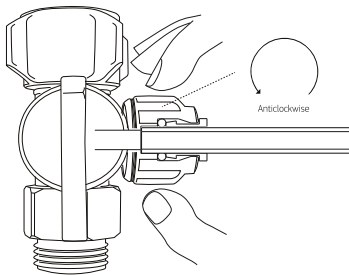

5. Turn the quick connect nut on the SmartTee™ anticlockwise to release the collet.

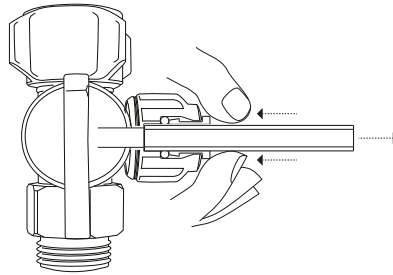

6. Push the collet against the quick connect nut and slide tube out of fitting.

Performance Data

Substance	Guidelines*	Average Influent Concentration	Max Effluent Concentration	Min Percent Removal	Average Effluent Concentration	Average Percent Removal
NSF Standard 42 Drinking Water Treatment Units						
Chlorine (23,000 L)	5 - Health 0.6 - Aesthetic	2.1	0.3	50%	0.25	>94%
Standard 53 Cyst Live Cryptosporidium POU/POE						
Cyst	<1	100,000	ND (1)	99.98% +	ND (1)	99.99%

Test Parameters	
Hardness, Total mg/L	120
TDS mg/L	290
Temp deg C	21°C
Turbidity NTU	0.1
pH	7.57

*Australian Drinking Water Guidelines - 1996
ND = Not Detected

This appliance meets the domestic water treatment appliance Standards AS/NZS3497 for the following water treatment processes:

Class	Treatment type	Function	Pass
I	Microbiological Status		
	Bacteriostatic	Will stop bacteria increasing, but will not remove them unless II(a) is passed	N/A
II	Microbiological Treatment		
II (a)	Bacteria Removal	Will remove or inactivate bacteria	N/A
II (b)	Virus Removal	Will remove or inactivate virus	N/A
II (c)	Protozoa Removal	Will remove or inactivate Cryptosporidium and Giardia, but will not remove or inactivate bacteria and viruses unless II(a) and II(b) is passed	YES
III	Turbidity & Particulate Reduction	Reduces cloudiness	YES
IV	Taste & Odour Reduction	Reduces taste & odours	YES
V	Chemical Treatment	Decreases chlorine	YES

Notes

Puretec water care products are designed, manufactured and supported by Puretec Pty Ltd the name you can trust for viable and proven water solutions. The complete range of Puretec products are developed, refined, made to meet and exceed stringent specifications for the worldwide market.

Important: Sales of products are subject to our Terms and Conditions which are available upon request. All specifications, information and photos are a guide only and are subject to change without notice. Please ring to confirm details. Warning: For correct operation of this appliance it is essential to observe manufacturer's instructions.

Warranty

Any claim under this warranty must be made within 10 years of the date of purchase of the product. This product is warranted to be free of defect of material and workmanship for 10 years from date of purchase. 10 year warranty is 1 year parts and labour plus 9 years parts only. Excludes cartridges.

Puretec is renowned for its quality and after-sales support so if you have any issues please call 1300 140 140 (AU) or 0800 130 140 (NZ). To make a warranty claim, contact us directly or the place of original purchase. All costs relating to a warranty claim must be approved by Puretec prior to any work being carried out.

Puretec will pay your reasonable, direct expenses of claiming under this warranty. You may submit details and proof of your expense claim to place of purchase for consideration.

The warranty only applies if the product was used and/or installed in accordance with the user guide and/or installation instructions. This warranty is given in lieu of all other express or implied warranties and manufacturer shall in no circumstance be held liable for damages consequential or otherwise or delays caused or faulty manufacturing except as excluded by law.

Applicable to all above, is that the warranties need to be approved by Puretec to ensure product was not incorrectly used, installed or claimed. False and incorrect claims will be pursued at Puretec's discretion, including chargeable inspection and labour costs incurred.

Warranty/Australia

This warranty is given by Puretec Pty Ltd, ABN 44 164 806 688, 37-43 Brodie Road, Lonsdale SA 5160, telephone no. 1300 140 140 and email at sales@puretec.com.au.

This warranty is provided in addition to other rights and remedies you have under law: Our goods come with guarantees which cannot be excluded under the Australian Consumer Law. You are entitled to replacement or refund for a major failure and to compensation for other reasonably foreseeable loss or damage. You are also entitled to have the goods repaired or replaced if the goods fail to be of acceptable quality and the failure does not amount to a major failure.

Warranty/New Zealand

This warranty is given by Puretec Ltd, Reg. No 4464398, PO Box 875 Cambridge 3450 NZ, telephone no. 0800 130 140 and email at sales@puretec.co.nz.

This warranty is provided in addition to other rights and remedies you have under law: Our goods come with guarantees which cannot be excluded under the Consumer Guarantees Act. You are entitled to replacement or refund for a major failure and to compensation for other reasonably foreseeable loss or damage. You are also entitled to have the goods repaired or replaced if the goods fail to be of acceptable quality and the failure does not amount to a major failure.

This page was intentionally left blank.

This page was intentionally left blank.



AUSTRALIA

P 1300 140 140

E sales@puretec.com.au

W puretec.com.au

NEW ZEALAND

P 0800 130 140

E sales@puretec.co.nz

W puretec.co.nz