

DOUBLE DRAWER

QUBO.

Michel César

QU90D2WH/QU90D2WHT/QU90D2WHVG/QU90D2WHTVG/
QU90D2WHPT/QU90D2WHPTD/QU90D2WHC/QU90D2WHCT



Product Feature

- + Paint — The paint used on our products is polyurethane or UV based. It is five times harder and more durable than lacquer finishes. Hundreds of gloss colour options available.
- + Timber finishes — Our timber finishes are available in Dark Oak, Natural Oak, White Oak, Walnut, Noce, Chestnut and Tussock. Being 100% natural products, each will have variations in grain and colour. All come stained and sealed with a protective UV finish. Gloss option is available for most veneers.

Vanity Finishes

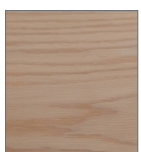

Blonde Oak



Natural Oak



White Oak



Noce



Walnut



Dark Oak



Chestnut

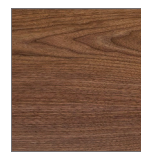

Tussock

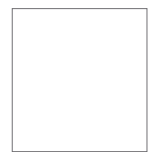

White Paint
Finish

NEW

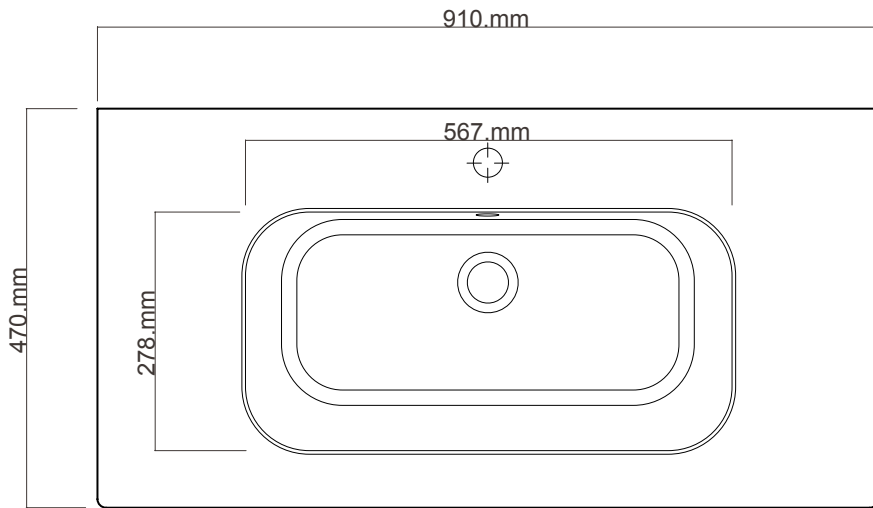

TOP WASHBASIN VIEW

NOTE : Drawing indicate the technical measurement only and is not a reflection of how the unit will look.

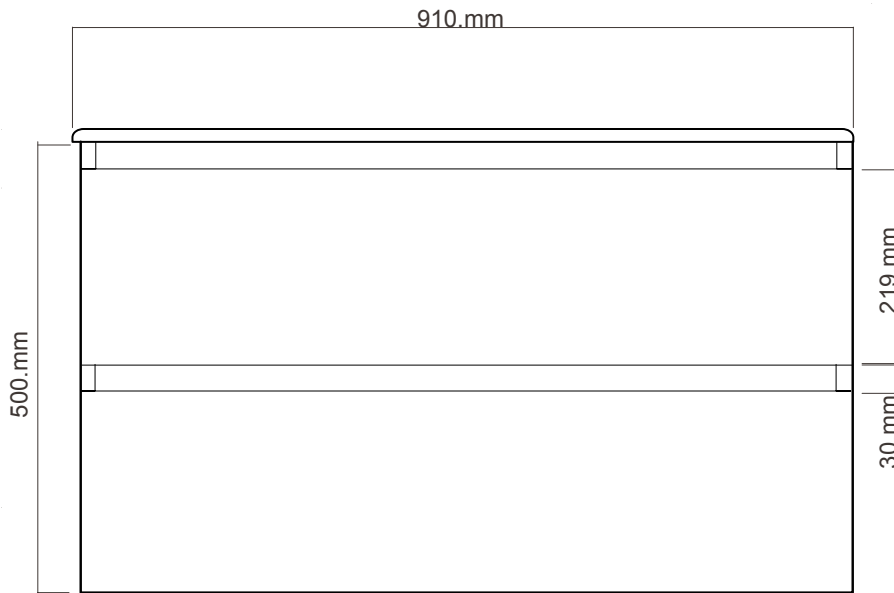

FRONT VIEW

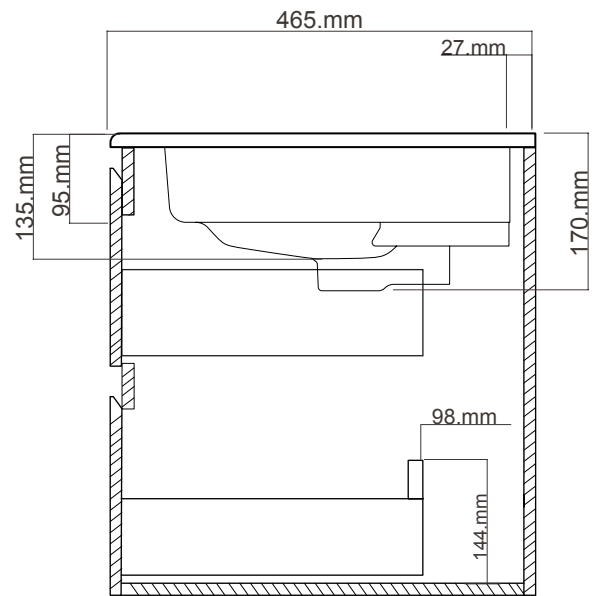

SIDE WASHBASIN VIEW

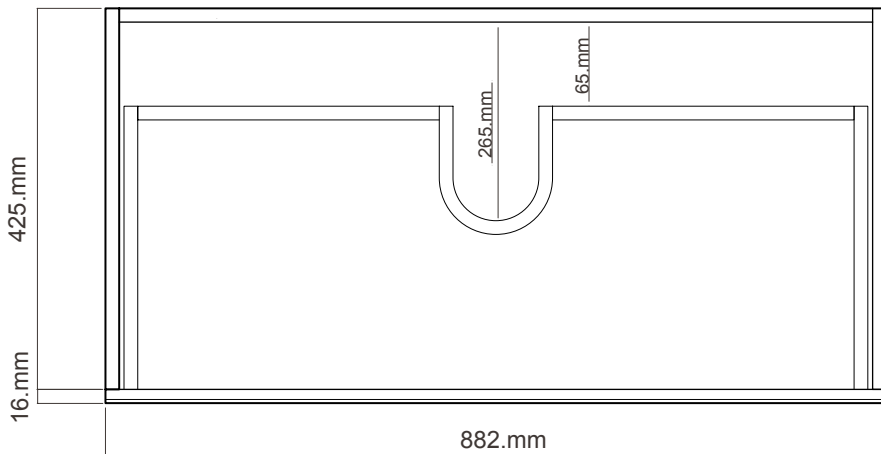

DRAWER

QUBO

Code: QU90D2WH

Description: Wall Hung Unit 910
2 Drawer, With Qubo
Ceramic Basin,