

SINGLE DRAWER TABLO.

Michel César



- + Three top thickness' available: Fine (12.6mm), Standard (25mm), and Deep (70mm).
- + Paint — The paint used on our products is polyurethane or UV based. It is five times harder and more durable than lacquer finishes. Hundreds of gloss colour options available.
- + Timber finishes — Our timber finishes are available in Dark Oak, Natural Oak, White Oak, Walnut, Noce, Chestnut and Tussock. Being 100% natural products, each will have variations in grain and colour. All come stained and sealed with a protective UV finish. Gloss option is available for most veneers.
- + Also available with double drawer.
- + Top made of a composite acrylic. Prices are for white but other colours include; porcelain, concrete, night, carrera and black storm.
- + Many basin options.

Vanity Finishes



Dark Oak

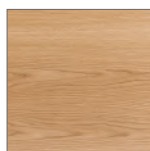

Natural Oak



White Oak



Noce



Walnut



Chestnut

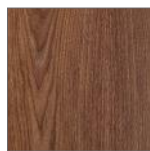

Tussock



White Paint Finish

Acrylic Top Finishes

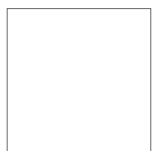

White

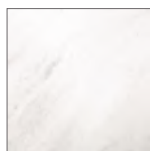

Carrera

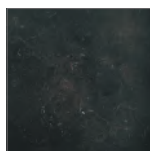

Black Storm

Note: Walnut Finish not available for vanity with Vertical Grooves

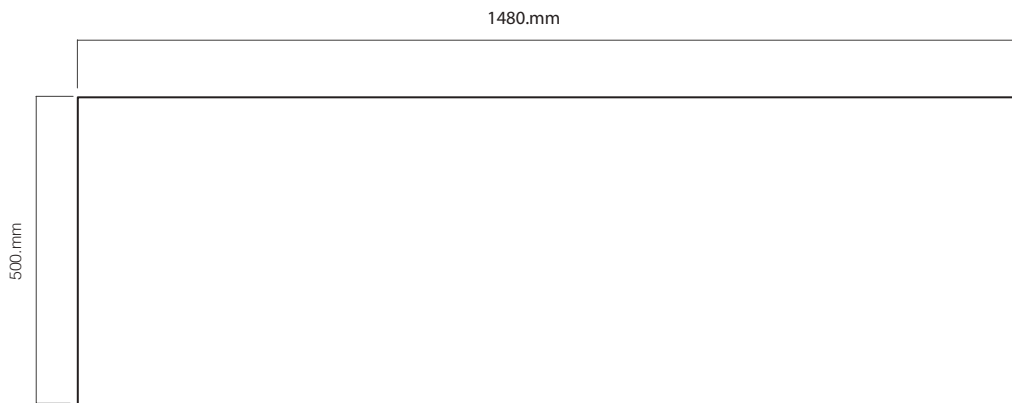

TOP VIEW

Top is available in 3 thicknesses

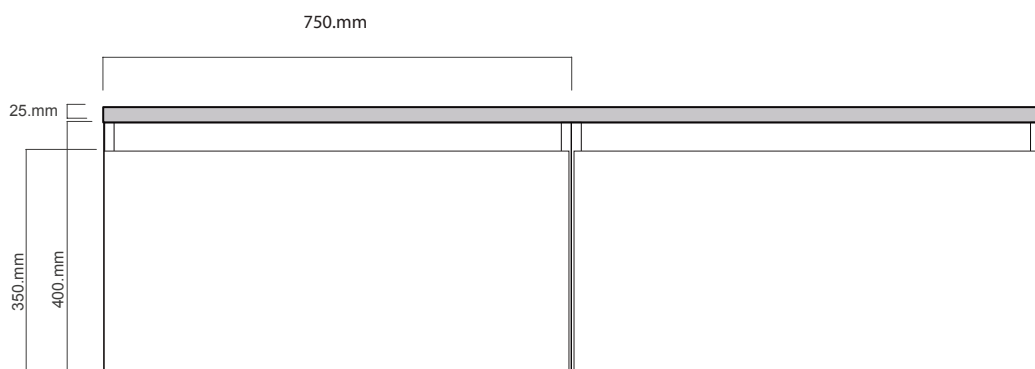

FRONT VIEW

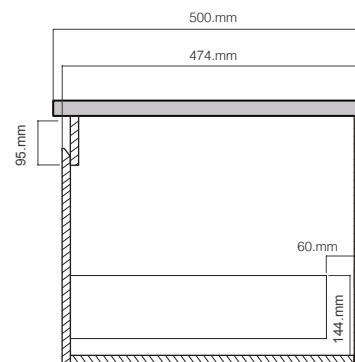

SIDE VIEW

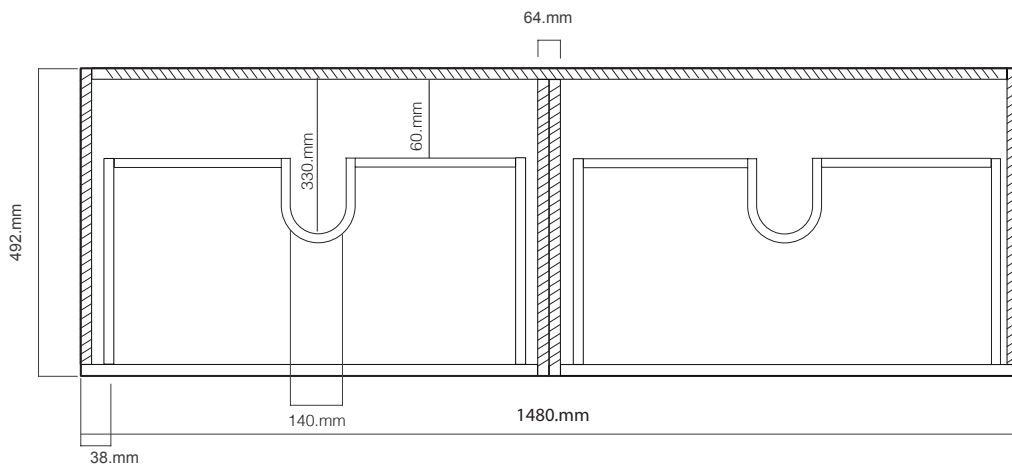

DRAWER

SINGLE DRAWER

TABLO.

TB150D2DB
TB150D2DBTA

Discription: Tablo
1500, 2 Drawer, Side-
by-Side
White/Timber Venner

Note: Drawing indicate the
technical measurement only and is
not a reflection of how the unit
will look.